

SONY®

SONY
Digital HD Video Camera Recorder
GB

Digital HD Video Camera Recorder

Operating Guide

Before operating the unit, please read this manual thoroughly,
and retain it for future reference

HDV
HDV 1080i

DVCAM™

Mini **DV** Digital
Video
Cassette

PROGRESSIVE

InfoLITHIUM™ **L**
SERIES

MEMORY STICK™

HDMI

HVR-Z7E/Z7P

© 2008 Sony Corporation

<http://www.sony.net/>

eco info
Printed on 70% or more recycled paper
using VOC (Volatile Organic Compound)
-free vegetable oil based ink.

Printed in Japan



3280848110

Read this first

Before operating this unit, please read this manual thoroughly, and retain it for future reference.

Notes on use

Types of cassette you can use in your camcorder

Your camcorder is capable of recording in HDV, DVCAM and DV formats.

When recording in HDV/DV format, Sony recommends that you use mini DV cassettes.

When recording in DVCAM format, Sony recommends that you use mini DVCAM cassettes. Your camcorder does not support the Cassette Memory function (p. 116).

The HDV format

- Digital high-definition (HD) video signals are recorded and played back on a DV format cassette.
- HDV signals are compressed in MPEG2 format, which is adopted in BS (broadcast satellite) digital and terrestrial digital HDTV broadcastings and in Blu-ray disc recorders.

Types of “Memory Stick” you can use in your camcorder

You can use any “Memory Stick” that has the following markings.

MEMORY STICK DUO MEMORY STICK PRO DUO
MEMORY STICK PRO-HG DUO

“Memory Stick Duo”

(This size can be used with your camcorder.)



“Memory Stick”

(You cannot use it in your camcorder.)



Notes

- You cannot use any type of memory card except “Memory Stick Duo.”
- “Memory Stick PRO Duo” can be used only with “Memory Stick PRO” compatible equipment.
- Do not attach a label or the like on a “Memory Stick Duo” or a Memory Stick Duo Adaptor.
- When using a “Memory Stick Duo” with “Memory Stick” compatible equipment, insert the “Memory Stick Duo” into the Memory Stick Duo Adaptor.

Using the camcorder

- Do not hold the camcorder by the following part.

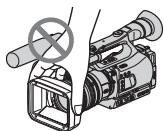

Lens hood

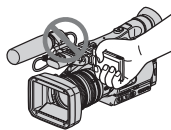

LCD panel



Microphone or
Microphone holder



Viewfinder



Accessory shoe
adaptor

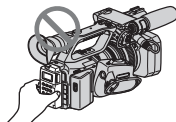

Memory recording
unit

Notes

- The camcorder is not dustproof, dripproof or waterproof.
See “About handling of your camcorder” (p. 122).
- Do not connect cables to your camcorder with their terminals placed the wrong way. Squeezing the terminals into your camcorder’s jacks may damage them or result in a malfunction of your camcorder.

About menu items, LCD panel, viewfinder, and lens

- A menu item that is grayed out is not available under the current recording or playback conditions.
- The LCD screen and the viewfinder are manufactured using extremely high-precision technology, so over 99.99% of the pixels are operational for effective use. However, there may be some tiny black points and/or bright points (white, red, blue, or green in color) that appear constantly on the LCD screen and the viewfinder. These points are normal results of the manufacturing process and do not affect the recording in any way.

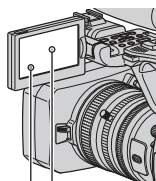

Black point
White, red, blue or green point

Do not expose your camcorder’s viewfinder, lens, or LCD screen to the sun or strong light source for extended periods.

- Intense light sources, especially the sun will converge on the viewfinder or lens and damage the internal parts of your camcorder. Avoid sunlight or other strong light sources when storing your camcorder. Protect this device by always closing the lens cover or by placing it in its bag when not in use.

On recording

- Before starting to record, test the recording function to make sure the picture and sound are recorded without any problems.

Read this first (Continued)

- Compensation for the contents of recordings cannot be provided, even if recording or playback is not possible due to a malfunction of the camcorder, storage media, etc.
- TV color systems differ depending on the countries/regions. To view your recordings on a TV, you need a PAL system-based TV.
- Television programs, films, video tapes, and other materials may be copyrighted. Unauthorized recording of such materials may be contrary to the copyright laws.
- Because of the way that the image device (CMOS sensor) reads out image signals, the subjects passing by the frame rapidly might appear crooked depending on the recording conditions. This phenomenon may be notable in displays having high motion resolution.

On playing back HDV tapes on other devices

A tape recorded in the HDV format cannot be played back on a device that is not compatible with the HDV format. Check the contents of tapes by playing them back on this camcorder prior to playing them back on other devices.

Notes on the icons used in this manual

 Features available for the HDV format only.

 Features available for the DVCAM format only.

 Features available for the DV SP format only.

 The function that can be used when i.LINK cable is connected.

 The function that can be assigned to an ASSIGN button.

About this manual

- The images of the LCD screen and the viewfinder used in this manual for illustration purposes are captured using a digital still camera, and therefore may appear different.
- The on-screen displays in each local language are used for illustrating the operating procedures. Change the screen language before using your camcorder if necessary (p. 21).
- Design and specifications of recording media and other accessories are subject to change without notice.

About the Carl Zeiss lens

Your camcorder is equipped with a Carl Zeiss lens, which was developed jointly by Carl Zeiss, in Germany, and Sony Corporation, and produces superior images. It adopts the MTF measurement system for video cameras and offers a quality typical of a Carl Zeiss lens. Also, the lens for your camcorder is T*-coated to suppress unwanted reflections and faithfully reproduce colors.

MTF= Modulation Transfer Function. The number value indicates the amount of light from a subject coming into the lens.

Table of Contents

Read this first	2
-----------------------	---

Getting Started

Step 1: Checking supplied items	8
Step 2: Attaching the supplied items	10
Step 3: Charging the battery pack	14
Step 4: Turning the power on and holding your camcorder properly	17
Step 5: Adjusting the LCD panel and viewfinder	18
Step 6: Setting the date and time	20
Step 7: Inserting a tape or a "Memory Stick Duo"	22









Recording/Playback

Recording	24
Changing the settings of your camcorder recordings	27
Adjusting the zoom	27
Adjusting the focus manually	28
Adjusting the exposure	30
Adjusting to natural color (White balance).....	32
Adjusting the black balance	33
Customizing the picture quality (Picture profile).....	33
Adjusting the volume	41
Assigning the functions to the ASSIGN buttons	43
Recording an index signal	44
Reviewing the most recently recorded scenes (Rec review).....	45
Searching for the last scene of the most recent recording (End search)	45
Playing back the most recently recorded movies (Last scene review).....	45
Using the Shot transition	46
Marking focal point on the screen (Focus marking)	49
Playback	50
Changing/checking the settings in your camcorder	53
Changing the screen	53
Displaying recording data (Data code)	53
Displaying the settings in your camcorder (Status check)	54
Checking the remaining battery (Battery Info).....	54
Locating a scene on a tape	55
Searching for a scene by date of recording (Date search)	55
Searching for a recording start point (Index search).....	55

Table of Contents (Continued)

Playing the picture on a TV	57
-----------------------------------	----

Using the Menu

<i>Using the menu items</i>	64
Menu items	66
 (CAMERA SET) menu	69
Settings to adjust your camcorder to the recording conditions (GAIN SETUP/ BACK LIGHT/STEADYSHOT, etc.)	
 (AUDIO SET) menu	76
Settings for the audio recording (DV AU.MODE/XLR SET, etc.)	
 (DISPLAY SET) menu	79
Display settings of the display and the viewfinder (MARKER/VF B.LIGHT/DISP OUTPUT, etc.)	
 (IN/OUT REC) menu	83
Recording settings, input and output settings (REC FORMAT/HDV PROGRE./ VIDEO OUT/EXT REC CTRL, etc.)	
 (TC/UB SET) menu	87
(TC PRESET/UB PRESET/TC LINK, etc.)	
 (MEMORY SET) menu	89
Settings for the "Memory Stick Duo" (ALL ERASE/FORMAT, etc.)	
 (OTHERS) menu	90
Settings while recording on a tape or other basic settings (QUICK REC/BEEP, etc.)	

Dubbing/Editing

Dubbing to VCR, DVD/HDD device, etc.	94
Recording pictures from a VCR	98
Copying movies on a tape to a computer	100

Troubleshooting

Troubleshooting	103
Warning indicators and messages	113

Additional Information

Using your camcorder abroad	115
Maintenance and precautions	116
HDV format and recording/playback	116
Compatibility of the DVCAM/DV formats	117
About the "Memory Stick"	119
About the "InfoLITHIUM" battery pack	120
About i.LINK	121
About x.v.Color	122
About handling of your camcorder	122
Specifications	126

Quick Reference

Identifying parts and controls	130
Indicators for the LCD screen and viewfinder	137
Index	140

Step 1: Checking supplied items

Make sure that you have following items supplied with your camcorder. The number in the parentheses indicates the number of that item supplied.

- The cassette tape and “Memory Stick Duo” are not included. See pages 2, 116 and 119 for types of cassette tapes and “Memory Stick Duo” that you can use on your camcorder.

Carl Zeiss lens (VCL-412BWH) (1) (p. 10)
This lens is pre-mounted.

Memory Recording Unit (HVR-MRC1) (1) (p. 13)



i.LINK Cradle (HVRA-CR1) (1) (p. 13)

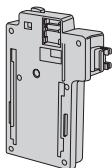

Rechargeable battery pack (NP-F570) (1) (p. 14, 120)

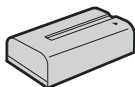

AC Adaptor/Charger (AC-VQ1050) (1) (p. 14)

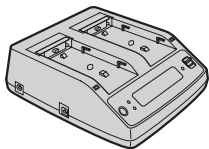

Large eyecup (1) (p. 19)



Lens hood with lens cover (1) (p. 12)
This lens hood is pre-mounted.

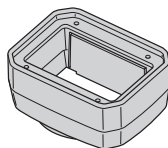

Wind Screen (1), Microphone (ECM-XM1) (1) (p. 12)

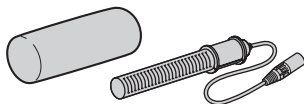

Accessory shoe adaptor (1) (p. 131)

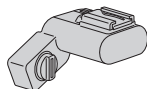

Accessory shoe kit (Accessory shoe (1), Accessory shoe plate (1), screws (4)) (p. 130)

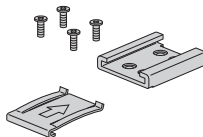

Lens mount cap (1) (p. 135),
Rear lens cap (1) (p. 135)
Wireless Remote Commander (RMT-831) (1) (p. 136)

A button-type lithium battery is already installed.

A/V connecting cable (1) (p. 57, 94)

Component video cable (1) (p. 57)

Connecting cord (DK-415) (1) (p. 16)
Test chart for flange focal length
adjustment (1) (p. 10)
CD-ROM "Manuals for Digital HD Video
Camera Recorder" (1)
Operating Guide (This manual) (1)

Step 2: Attaching the supplied items

Mounting the lens

Make sure to turn off the POWER switch of your camcorder before mounting the lens. Refer to the manuals provided with the lens for details on the proper handling of the lens.

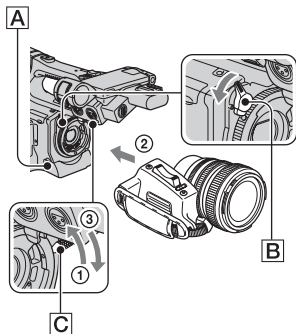

Mounting the Carl Zeiss lens

- 1 Push the lens locking lever **C** up and remove the lens or the lens mount cap from the lens mount.
- 2 Align the center slot in the lens mount with the center pin on the lens, and insert the lens into the mount.
- 3 While holding the lens in place, push the lens locking lever **C** down to mount the lens.

⚠ Notes

- If the lens is not properly locked, it may come off when in use, which may cause a serious problem. Make sure that the lens is securely locked. Sony recommends that you set the lens securing tab **B** as illustrated.

Mounting non-Carl Zeiss lens

- 1 Push the lens locking lever **C** up and remove the lens or the lens mount cap from the lens mount.

- 2 Align the center slot in the lens mount with the center pin on the lens, and insert the lens into the mount.
- 3 While holding the lens in place, push the lens locking lever **C** down to mount the lens.
- 4 Connect the lens cable to the LENS jack **A**.

⚠ Notes

- You can mount a 1/3" lens directly on your camcorder. You can mount a 1/2" lens via the Fujinon ACM-19 or equivalent. You can mount a 2/3" lens via the Fujinon ACM-17 or equivalent.
- If the lens is not properly locked, it may come off when in use, which may cause a serious problem. Make sure that the lens is securely locked. Sony recommends that you set the lens securing tab **B** as illustrated.
- Press the REC START/STOP button on the handle or the START/STOP button on the Remote Commander to record when using a lens that does not have a lens cable.

💡 Tips

- When you attach a non-Carl Zeiss lens, Sony recommends that you adjust the black balance with the iris closed before recording. (p. 33)

Adjusting the flange focal length (for Carl Zeiss lens)

You need to adjust the flange focal length (the distance from the lens flange to the plane of the image along the optical axis) in the following cases.

- After you have changed lenses.
- When you cannot adjust focus properly during zoom in or out.

💡 Tips

- Your camcorder can store flange focal length data for ten different Carl Zeiss lenses (VCL-412BWH/VCL-308BWH). If you remount the lens after you have mounted ten different lenses and adjusted their flange focal length, you need to adjust the flange focal length for the lens even for the Carl Zeiss lens whose flange focal length has been adjusted.

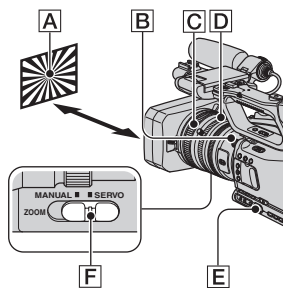

Adjusting the flange focal length automatically

- ① Set the ND filter **B** to 1 to adjust brightness so that the proper video light level is obtained.
- ② Place the flange focal length adjustment test chart **A** about 2-3 meters (7-10 feet) away. Zoom in and set your camcorder to locate the center of the chart in the center of the screen.
- ③ Set the ZOOM switch **F** to SERVO.
- ④ Select [AUTO ADJUST] in [FLANGE BACK] of the (CAMERA SET) menu (p. 76).
- ⑤ Select [YES] with the SEL/PUSH EXEC dial **E**.

The flange focal length adjustment starts and [EXECUTING] appears on the screen. When the adjustment is completed, [Completed.] appears on the screen. If the adjustment fails, [Could not adjust.] appears on the screen. Try the adjustment again.

Adjusting the flange focal length manually

- ① Perform steps ① and ② of “Adjusting the flange focal length automatically.”
- ② Set the ZOOM switch **F** to MANUAL.
- ③ Select [MANU ADJUST] in [FLANGE BACK] of the (CAMERA SET) menu.

- ④ Select [YES] with the SEL/PUSH EXEC dial **E**.
- ⑤ Turn the zoom ring **D** to the telephoto position.
- ⑥ Turn the focus ring **C** until the subject comes in focus, then press the SEL/PUSH EXEC dial **E**.
- ⑦ Turn the zoom ring **D** to the wide angle position.
- ⑧ Turn the focus ring **C** until the subject comes in focus, then press the SEL/PUSH EXEC dial **E**.

When the adjustment is completed, [Completed.] appears on the screen. If the adjustment fails, [Could not adjust.] appears on the screen. Try the adjustment again.

💡 Tips

- You can check the focusing easily if you do the following before adjusting the focal length.
 - Set [PEAKING] in the (DISPLAY SET) menu to [ON] (p. 79).
 - Press the ASSIGN button to which [EXP.FOCUS] is assigned (L2 button by default) (p. 43).

Step 2: Attaching the supplied items (Continued)

Attaching the supplied microphone

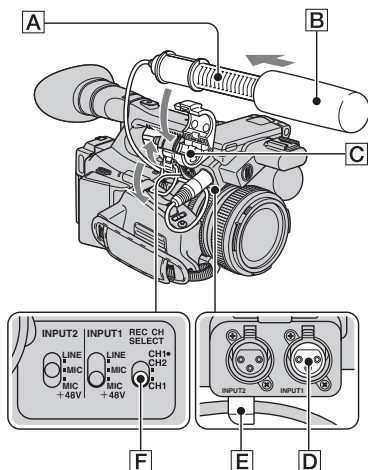

- 1 Attach the wind screen **B** to the supplied microphone **A**.
- 2 Place the microphone **A** in the microphone holder **C** with the model name facing upward, close the cover, and shut the clamp.
- 3 Connect the plug of the microphone to the INPUT1 jack **D**.
- 4 Put the microphone cable into the cable holder **E**.
- 5 Select the channel with the REC CH SELECT switch **F**.

The channel to be used differs depending on the relationship between the REC CH SELECT switch positions and the input jacks. See the table below.

REC CH SELECT switch position	Input jack	Channel to be used
CH1, CH2	INPUT1	Channel1 Channel2
	INPUT2	-
CH1	INPUT1	Channel1
	INPUT2	Channel2

💡 Tips

- See page 41 for adjusting the volume.
- Set the INPUT1/INPUT2 switch to MIC+48V when you use the supplied microphone.

Attaching the lens hood with lens cover

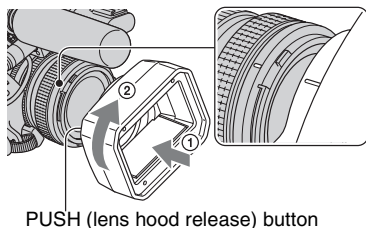

PUSH (lens hood release) button

Align the marks on the lens hood to those on the camcorder, and turn the lens hood in the direction of the arrow ②.

To remove the Lens hood with lens cover

Turn the lens hood in the opposite direction to the arrow ② in the illustration while

pressing the PUSH (lens hood release) button.

💡 Tips

- If you attach or remove a 72mm (2 7/8 in.) PL filter or MC protector, remove the lens hood with lens cover.

To open or close the shutter of the Lens hood with lens cover

Move the lens cover lever up or down to open or close the lens cover.

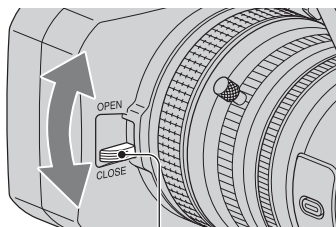

Move the lens cover lever to OPEN to open the lens cover, and move the lever to CLOSE to close the lens cover.

Attaching Memory Recording Unit

Make sure that the  HDV/DV jack cover is closed.

Attach the Memory Recording Unit to your camcorder as illustrated.

For details, refer to the Operating Instructions of the Memory Recording Unit on the CD-ROM.

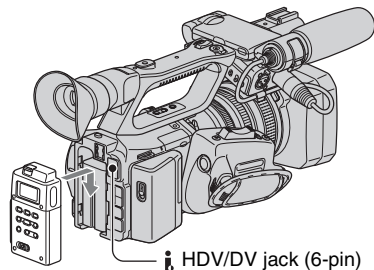

⚠ Notes

- You cannot use the  HDV/DV jack when the Memory Recording Unit is attached to your camcorder.

To remove the Memory Recording Unit

Slide the unit upward while pushing the RELEASE lever of the Memory Recording Unit downward.

To attach the Memory Recording Unit to the i.LINK Cradle

Attach the Memory Recording Unit to the i.LINK Cradle as illustrated.

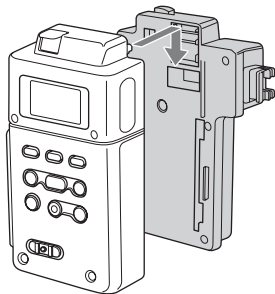

To remove the Memory Recording Unit from the i.LINK Cradle

Slide the unit upward while pushing the RELEASE lever of the Memory Recording Unit downward.

💡 Tips

- Refer to the operating instructions of HVR-MRC1 on the supplied CD-ROM for details on the i.LINK cradle.

Step 3: Charging the battery pack

You can charge the "InfoLITHIUM" battery pack (L series) with the supplied AC Adaptor/Charger.

Notes

- You cannot use batteries other than the "InfoLITHIUM" battery pack (L series) (p. 120).

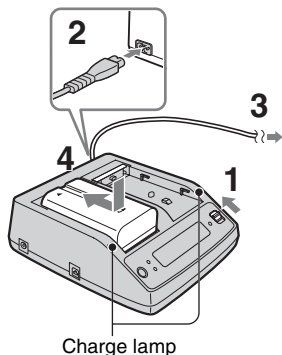

1 Set the mode change switch to **CHARGE**.

2 Connect the mains lead to the **AC Adaptor/Charger**.

3 Connect the mains lead to the **wall socket**.

4 Place the battery pack in the slot of the **AC Adaptor/Charger**, press it down, and slide it in the direction of the arrow as illustrated.

The charge lamp turns on and charging starts.

After charging the battery

All segments of the battery mark () appear in the display window when the normal charge of the battery is completed. You can fully charge the battery pack if you continue charging the battery pack after the charge lamp turns off until the battery mark with "FULL" appears (full charge). The battery life of the fully charged battery is slightly longer than that of the normally charged battery.

Remove the battery pack from the AC Adaptor/Charger when the charge is completed.

Tips

- You can check the remaining battery life with the battery info function (p. 54).

To attach the battery pack

Press the battery pack against the back of your camcorder and slide it down.

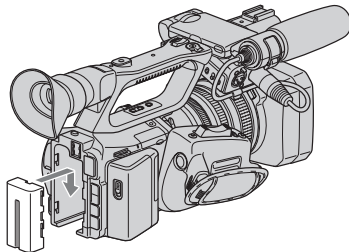

To remove the battery pack

Slide the POWER switch to OFF. Push the BATT RELEASE (battery release) button and remove the battery pack.

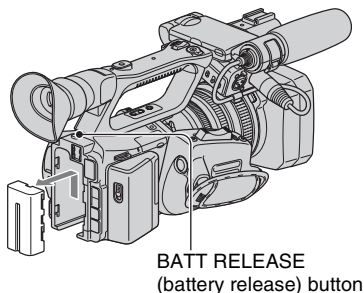

BATT RELEASE
(battery release) button

To store the battery pack

If the battery pack will not be used for a while, run down the battery and store it. See page 121 for details on storage of the battery pack.

Charging time

Approximate time (min.) required when you fully charge a fully discharged battery pack.

Battery pack	Charging time
NP-F570 (supplied)	145
NP-F770	230
NP-F970	310

Recording time

Approximate time (min.) available when you use a fully charged battery pack.

Notes

- You cannot use the NP-F330 battery pack with this camcorder.

Recording in the HDV format

Battery pack	Continuous recording time	Typical recording time*
NP-F570 (supplied)	130	75
	130	75
NP-F770	265	155
	270	155
NP-F970	395	235
	400	235

Recording in the DVCAM (DV) format

Battery pack	Continuous recording time	Typical recording time*
NP-F570 (supplied)	130	75
	135	75
NP-F770	275	160
	280	160
NP-F970	410	240
	415	240

Top: When the LCD backlight turns on.

Bottom: When recording with the viewfinder while the LCD panel is closed.

* Typical recording time shows the time when you repeat recording start/stop, turning the power on/off and zooming.

Playing time

Approximate time (min.) available when you use a fully charged battery pack.

HDV format pictures

Battery pack	LCD panel opened*	LCD panel closed
NP-F570 (supplied)	175	180
NP-F770	360	375
NP-F970	545	570

Step 3: Charging the battery pack (Continued)

DVCAM (DV) format pictures

Battery pack	LCD panel opened*	LCD panel closed
NP-F570 (supplied)	180	190
NP-F770	375	390
NP-F970	570	595

* When the LCD backlight turns on.

On the battery pack

- Before changing the battery pack, slide the POWER switch to OFF.
- The Battery Info (p. 54) will not be correctly displayed under the following conditions.
 - The battery pack is not attached correctly.
 - The battery pack is damaged.
 - The battery pack is worn-out (For Battery Info only).
- Sony recommends that you use an NP-F970 battery pack when you use your camcorder with the Memory Recording Unit or a video light (optional).

On the charging/recording/playback time

- Times measured with the camcorder at 25 °C (77 °F) (10 to 30 °C (50 °F to 86 °F)) is recommended).
- The recording and playback time will be shorter when you use your camcorder in low temperatures.
- The recording and playback time will be shorter depending on the conditions under which you use your camcorder.

Using an outside power source

You can use the AC Adaptor/Charger to obtain AC power.

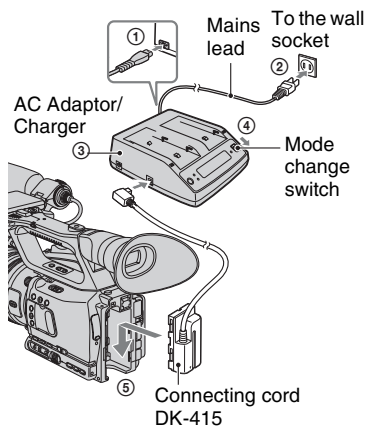

- ① Connect the mains lead to the AC Adaptor/Charger.
- ② Connect the mains lead to the wall socket.
- ③ Connect the connecting cable (DK-415) to the AC Adaptor/Charger.
- ④ Set the mode change switch of the AC Adaptor/Charger to VCR/CAMERA.
- ⑤ Press the connecting part of the connecting cable (DK-415) against the back of your camcorder in the battery slot and slide it down.

On the AC Adaptor/Charger

- Use the nearby wall outlet when using the AC Adaptor/Charger. Disconnect the AC Adaptor/Charger from the wall outlet immediately if any malfunction occurs while using your camcorder.
- Do not use the AC Adaptor/Charger placed in a narrow space, such as between a wall and furniture.
- Do not short-circuit the DC plug of the AC Adaptor/Charger or battery terminal with any metallic objects. This may cause a malfunction.
- Even if your camcorder is turned off, AC power (house current) is still supplied to it while connected to the wall outlet via the AC Adaptor/Charger.

Step 4: Turning the power on and holding your camcorder properly

To record or play back, set the POWER switch to the respective positions. When you use your camcorder for the first time, the [CLOCK SET] screen appears (p. 20).

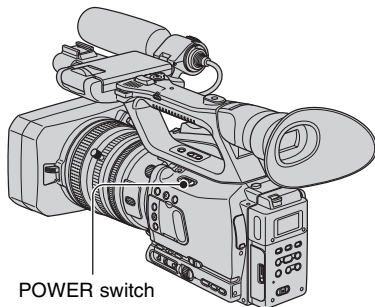

POWER switch

1 Slide the POWER switch to **CAMERA** or **VCR** while you press the green button.

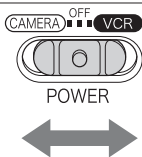

Slide the POWER switch while pressing the green button.

CAMERA: To record pictures.
VCR: To play or edit pictures.

Notes

- The current date and time appear on the LCD screen for a few seconds when you turn on your camcorder once you set the date and time ([CLOCK SET], p. 20).

2 Hold the camcorder properly.

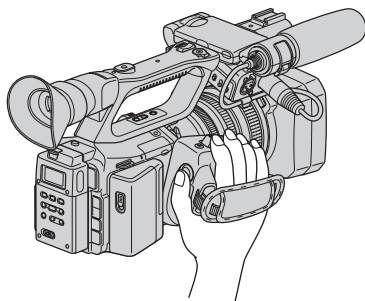

3 Ensure a good grip, then fasten the grip belt.

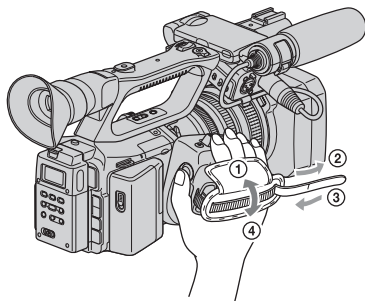

To turn off the power

Slide the POWER switch to OFF while pressing the green button.

Notes

- If warning messages appear on the screen, follow the instructions.

Step 5: Adjusting the LCD panel and viewfinder

The LCD panel

Open the LCD panel 180 degrees (①), then rotate it to the best angle to record or play back (②).

① Open 180 degrees.

② 90 degrees (max.)

③ 180 degrees (max.)

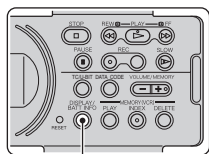

DISPLAY/BATT INFO button

💡 Tips

- You can see your mirror image on the LCD screen by setting the LCD panel facing you. The image will be recorded in a normal image.

To turn off the LCD backlight to make the battery last longer

Press and hold the DISPLAY/BATT INFO button for a few seconds until \square_{OFF} appears. This setting is practical when you use your camcorder in bright conditions or when you want to save battery power. The recorded picture will not be affected by the setting. To turn on the LCD backlight, press and hold the DISPLAY/BATT INFO button for a few seconds until \square_{OFF} disappears.

💡 Tips

- You can adjust the brightness of the LCD screen from [LCD BRIGHT] (p. 82).

The viewfinder

Viewfinder lens adjustment lever

Move it until the picture becomes clear.

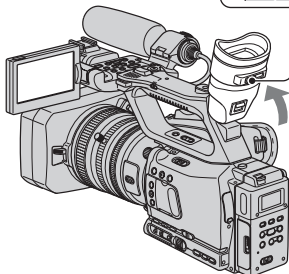
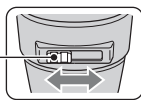

⚠ Notes

- You may see primary colors shimmering in the viewfinder when you move your eye line. This is not a malfunction. The shimmering colors will not be recorded on the recording media.

💡 Tips

- You can adjust the brightness of the viewfinder backlight from [VF B.LIGHT] (p. 82).
- To display images both on the LCD display and in the viewfinder, set [VF POWERMODE] to [ON] (p. 82).
- To display images in black and white in the viewfinder, set [VF COLOR] to [OFF] (p. 82).

When the picture in the viewfinder is hard to see

If you cannot see the picture in the viewfinder clearly under bright circumstances, use the supplied large eyecup. To attach the large eyecup, stretch it slightly and align it with the eyecup groove in the viewfinder. You can attach the large eyecup facing either the right or left side.

🔊 Notes

- Do not remove the pre-attached eyecup.

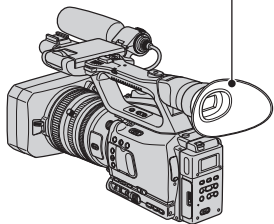
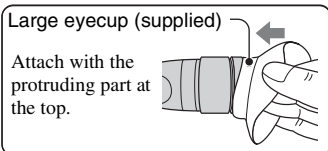

Step 6: Setting the date and time

Set the date and time when using your camcorder for the first time. If you do not set the date and time, [CLOCK SET] screen appears every time you turn on your camcorder or change the POWER switch positions.

💡 Tips

- If you do not use your camcorder for **about 3 months**, the built-in rechargeable battery gets discharged and the date and time settings may be cleared from the memory. In that case, charge the rechargeable battery and then set the date and time again (p. 125).

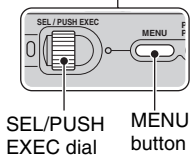
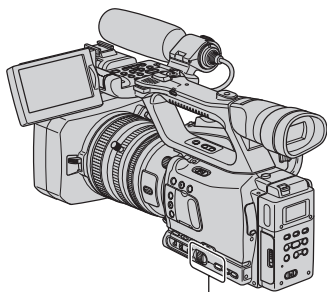

Skip to step **4** when you set the clock for the first time.

1 Press the MENU button.

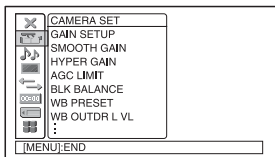

2 Select [OTHERS] by turning the SEL/PUSH EXEC dial, then press the dial.

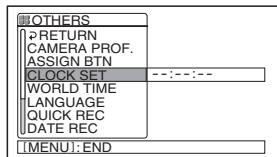

3 Select [CLOCK SET] by turning the SEL/PUSH EXEC dial, then press the dial.

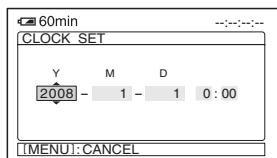

4 Set [Y] (year) by turning the SEL/PUSH EXEC dial, then press the dial.

You can set any year up to the year 2079.

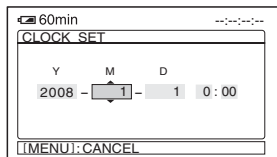

5 Set [M] (month), [D] (day), hour and minute, then press the dial.

The clock starts.

Tips

- The date and time are automatically recorded on the tape, and can be displayed during playback (DATA CODE button, p. 53).

Changing the language setting

You can change the on-screen displays to show messages in a specified language.

Select the screen language in [LANGUAGE] (p. 91).

Step 7: Inserting a tape or a “Memory Stick Duo”

Cassette tape

See page 116 for details on tapes including which tapes can be used and how to protect from overwriting tapes.

- 1 Slide and hold the OPEN/EJECT lever in the direction of the arrow and open the lid.

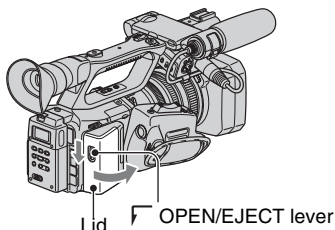

The cassette compartment automatically comes out.

- 2 Insert a cassette with its window facing outwards, then press **[PUSH]**.

Push the center of the back of the cassette lightly.

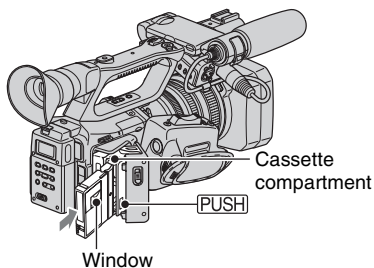

The cassette compartment automatically slides back in.

Notes

- Do not push the portion marked **[DO NOT PUSH]** while the cassette compartment is sliding in. Doing so may cause a malfunction.

- 3 Close the lid.

Tips

- The recordable time varies depending on [DV REC MODE] (p. 84).

To eject the cassette

Open the lid following the same procedure as described in step 1 and remove the cassette.

“Memory Stick Duo”

You can use only a “Memory Stick Duo” marked with **MEMORY STICK DUO**, **MEMORY STICK PRO DUO** or **MEMORY STICK PRO-HG DUO** (p. 119).

- 1 Open the Memory Stick Duo slot cover in the direction of the arrow.

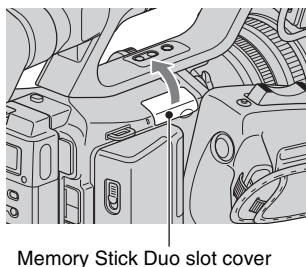

-
- 2** Insert the “Memory Stick Duo” into the Memory Stick Duo slot in the right direction until it clicks.

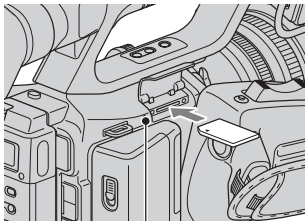

Access lamp

ⓘ Notes

- If you insert the “Memory Stick Duo” into the slot in the wrong direction, the “Memory Stick Duo,” the Memory Stick Duo slot, or image data may be damaged.

To eject a “Memory Stick Duo”

Lightly push the “Memory Stick Duo” once.

ⓘ Notes

- When the access lamp is lit or flashing, your camcorder is reading/writing data. Do not shake or knock your camcorder, turn the power off, eject the “Memory Stick Duo,” or remove the battery pack. Otherwise, image data may be damaged.
- When inserting or ejecting the “Memory Stick Duo,” be careful with the “Memory Stick Duo” from popping out and dropping.

Recording

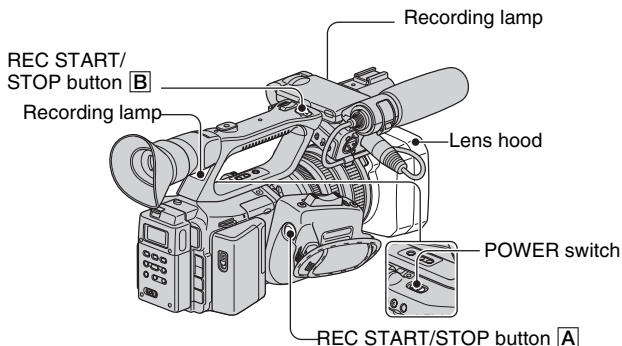

Your camcorder records movies on tape and still images on “Memory Stick Duo.” Do the following steps to record movies.

- This camcorder can record movies in HDV or DVCAM (DV) format. The factory setting is HDV format ([REC FORMAT] p. 83).

1 Open the shutter of the lens hood.

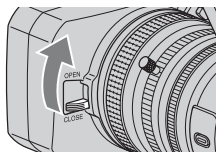

2 Slide the POWER switch to CAMERA while pressing the green button.

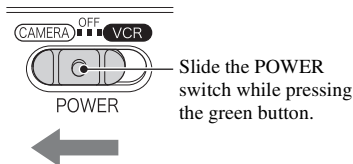

3 Press the REC START/STOP button **A** (or **B**).

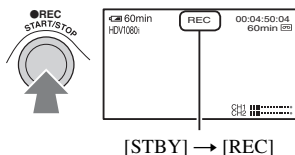

The recording lamp lights up during recording.

To stop the movie recording, press the REC START/STOP button again.

Tips

- When recording in HDV format, the aspect ratio is fixed to 16:9. When recording in DVCAM (DV) format, you can switch the aspect ratio to 4:3 ([DV WIDE REC] p. 85).
- You can change the screen display during recording (p. 53).
- Indicators displayed on the screen during recording are shown on page 137.
- The recording lamp can be set to stay off ([REC LAMP[F]], [REC LAMP[R]] p. 92).
- You cannot record movies on a "Memory Stick Duo."
- For low angle recording, the REC START/STOP button on the handle is convenient. Release the HOLD lever to enable the REC START/STOP button. It might be helpful if you set the LCD panel face up or close it after turning it face down, or lift the viewfinder up during the low angle recording.

Recording (Continued)

To capture still images





- ① Assign [PHOTO] to an ASSIGN button.
- ② Press the ASSIGN button to which [PHOTO] is assigned or the PHOTO button on the Remote Commander. A still image will be recorded on the “Memory Stick Duo.”  appears when the recording is completed.

You can capture still images during movie recording.

Tips

- See page 139 for indicators that appear on the screen during recording.

Capacity of the “Memory Stick Duo” (MB) and the number of recordable pictures

	1.2M 1440 × 810 	0.9M 1080 × 810 	VGA 640 × 480 	0.2M 640 × 360 
256MB	370	500	1400	1750
512MB	770	1000	2900	3650
1GB	1550	2100	6000	7500
2GB	3150	4300	12000	15000
4GB	6300	8500	23500	29500
8GB	12500	17000	48000	60000

Notes

- Specifications are for Sony “Memory Stick Duo.” The actual number of recordable pictures can vary depending on the recording environment and the type of “Memory Stick Duo.”

Tips

- Image sizes of still images are as follows:
 - Recording in HDV format/DVCAM (DV) format (16:9): 1.2M
 - Recording in DVCAM (DV) format (4:3): 0.9M
 - Playing back in HDV format: 1.2M
 - Playing back in DVCAM (DV) format (16:9): 0.2M

- Playing back in DVCAM (DV) format (4:3): VGA

To store still images captured from movies on a tape on “Memory Stick Duo”

You can capture an image in a movie and record it on a “Memory Stick Duo” as a still image. Be sure to insert a recorded tape and a “Memory Stick Duo” in your camcorder, Assign [PHOTO] to any one of ASSIGN buttons (p. 43).

- ① Set the POWER switch to VCR.
- ② Press the  (play) button to search for the scene you want to save as a still image. Press the ASSIGN button to which [PHOTO] is assigned or the PHOTO button on your Remote Commander at the scene.

Notes

- The recorded date and time on the tape and the stored date and time on the “Memory Stick Duo” are both saved on the “Memory Stick Duo.” When you view the still images, only the recorded date and time on the tape will be displayed on the screen (Data code, p. 53).
- Camera data stored on the tape will not be copied to the “Memory Stick Duo.”
- You cannot store a still image during using your camcorder with [PB ZOOM] set to [ON] (p. 92).
- You cannot store a still image under the following conditions:
 - When the shutter speed is slower than 1/50
 - While using the fader
 - While using smooth slow rec
 - While using shot transition
 - When [SCAN TYPE] is set to [25] (p. 84)

Changing the settings of your camcorder recordings

Adjusting the zoom

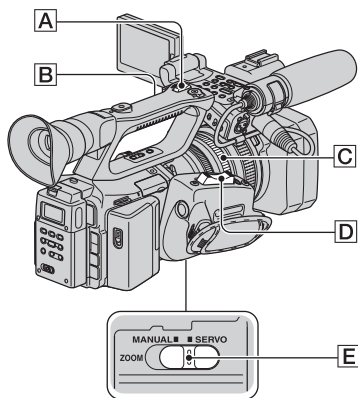

Using the zoom lever

Set the ZOOM switch **E** to SERVO. Move the power zoom lever **D** slightly for a slower zoom. Move it further for a faster zoom.

Wide view: (Wide angle)

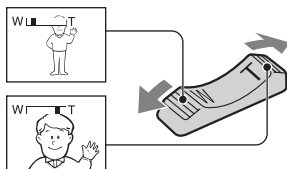

Close view: (Telephoto)

💡 Tips

- The minimum distance required between your camcorder and the subject for focus is about 1 cm (about 13/32 in.) for wide angle and about 80 cm (about 2 5/8 feet) for telephoto.
- The focus may not be adjusted at certain zoom positions if the subject is within 80 cm (about 2 5/8 feet) from your camcorder.

- When you set [FOCUS MACRO] to [OFF] or the focus ring to the mode A position (p. 28), you cannot focus on a subject within 80 cm (about 2 5/8 feet) regardless of the zoom position (p. 72).
- Be sure to keep your finger on the power zoom lever **D**. If you move your finger off the power zoom lever **D**, the operation sound of the power zoom lever **D** may also be recorded.

Using the handle zoom

- ① Set the ZOOM switch **E** to SERVO.
- ② Set the handle zoom switch **B** to VAR or FIX.

💡 Tips

- When you set the handle zoom switch **B** to VAR, you can zoom in or out at variable speed.
 - When you set the handle zoom switch **B** to FIX, you can zoom in or out at fixed speed set in [HANDLE ZOOM] (p. 72).
- ③ Press the handle zoom lever **A** to zoom in or out.

⚠ Notes

- You cannot use the handle zoom lever **A** when the handle zoom switch **B** is set to OFF.
- You cannot change the zoom speed of the zoom lever **D** with the handle zoom switch **B**.

Using the zoom ring

You can zoom at the desired speed by turning the zoom ring **C**. Fine adjustment is also possible.

- ① Set the ZOOM switch **E** to MANUAL.
- ② Turn the zoom ring **C** to zoom in or out.

💡 Tips

- You can remove the zoom pin.

Adjusting the focus manually

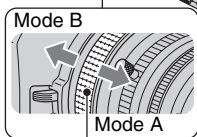
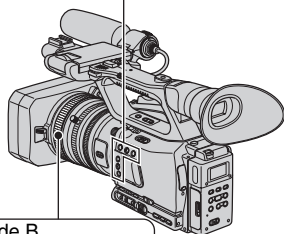
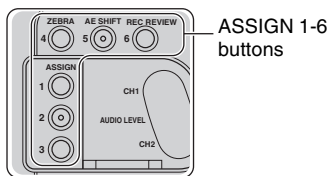

Focus ring

You can adjust the focus manually for different recording conditions. Use this function in the following cases.

- To record a subject behind a window covered with raindrops.
- To record horizontal stripes.
- To record a subject with little contrast between the subject and its background.
- When you want to focus on a subject in the background.

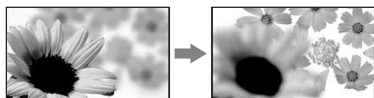

- To record a stationary subject using a tripod.

Adjusting focus manually in mode A

In mode A, you can manually adjust focus without automatic adjustment functions. Set the focus ring to the mode A position and focus manually using the focus scale on the lens.

Notes

- Turn the focus ring slowly. If it is forced against either end, the focus ring may move toward the mode B position and move past the end, and make noises.

Adjusting focus manually in mode B

In mode B, you can use the automatic adjustment functions during manual focus adjustment. Set the focus ring to the mode B position and do the following steps.

- ① Assign [FOCUS] to an ASSIGN button (p. 43).
- ② Press the ASSIGN button to which [FOCUS] is assigned.
☒ appears on the screen.
- ③ Turn the focus ring to adjust the focus.
☒ changes to ▲ when you cannot bring any further subject in focus. ☒ changes to ■ when you cannot bring any closer subject in focus.

Tips

For manual focus

- Zoom in and bring your camcorder in focus, then gradually zoom out.
- Fully zoom out and gradually zoom in when you shoot a close subject.

To restore automatic adjustment

Press the ASSIGN button to which [FOCUS] is assigned once again. ☒ disappears and the automatic focus adjustment is restored.

Tips

- If you want to adjust focus automatically or use automatic adjustment functions such as one push auto focus during manual focus

adjustment, set the focus ring to mode B. You cannot use the automatic adjustment functions in mode A.

Using automatic focus temporarily (One push auto focus)

You can use this function only in mode B. Do steps ① and ② of “Adjusting focus manually in mode B” in advance.

- ① Assign [ONE PUSH AF] to an ASSIGN button (p. 43).
- ② Record a movie while holding the ASSIGN button to which [ONE PUSH AF] is assigned.
Automatic focus functions as long as you hold the ASSIGN button (☞ disappears).

💡 Tips

- The focal distance is always displayed while you turn the focus ring in mode A. In mode B, the focal distance is displayed for about 3 seconds in the following cases:
 - When you press the ASSIGN button to which [FOCUS] is assigned (☞ appears on the screen).
 - When you turn the focus ring while ☞ is displayed on the screen.

The focal distance is not displayed when you use non-Carl Zeiss lenses.

Using the expanded focus (Expanded focus)

During standby, press the ASSIGN button to which [EXP.FOCUS] is assigned. [EXPANDED FOCUS] appears and the center of the screen is magnified by about 2.0 times. It will be easier to confirm the focus setting during manual focusing. The screen returns to the original size when you press the button again.

🔍 Notes

- You cannot use the expanded focus when [REC CTL MODE] in [EXT REC CTRL] is set to other than [OFF] (p. 86).

- The center of the screen is magnified by about 1.5 times when [SCAN TYPE] in [HDV PROGRE.] or [DV PROGRE.] of the ⇄ (IN/OUT REC) menu is set to [25].
- The screen returns to the original size when you start recording during the expanded focus display.

💡 Tips

- You can select a type of an expanded image displayed during the expanded focus ([EXP.FOCUS TYPE] p. 80).

Focusing on a distant subject (Focus infinity)

🔍 Notes

- Focus infinity is available when the focus ring is set to the mode B position. It is not available during the auto focus.

- ① Assign [FOCUS INFNTY] to an ASSIGN button (p. 43).
- ② Press the ASSIGN button to which [FOCUS INFNTY] is assigned.
▲ appears on the screen.

If you release the button, your camcorder returns to the manual focus mode. This function enables you to set focus on a distant subject even when the focus is automatically set on a close subject.

Changing the settings of your camcorder recordings (Continued)

Adjusting the exposure

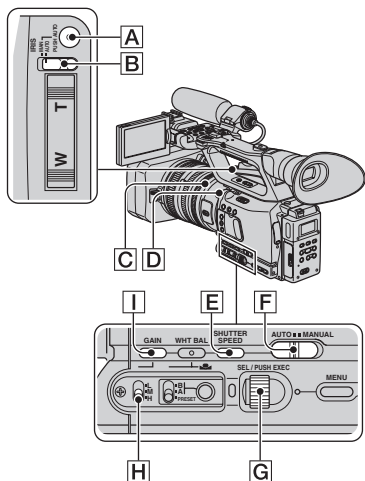

Adjusting the iris

You can manually adjust the iris to control the volume of the light entering the lens. By adjusting the iris, you can change or close the aperture of the lens, which is expressed as an F value between F1.6 and F11. The volume of the light increases the more that you open the aperture (decreasing F value). The volume of the light decreases the more that you close the aperture (increasing F value). The current F value appears on the screen.

- ① During recording or standby, set the AUTO/MANUAL switch **[F]** to MANUAL.
- ② Set the IRIS switch **[B]** to MAN.
- ③ Adjust the iris with the iris ring **[C]**. During the manual iris adjustment, you can temporarily return to the auto iris adjustment while holding down the PUSH AUTO button **[A]**.

💡 Tips

- The F value becomes close to F2.0 as the zoom position changes from W to T even when you open the aperture by setting the F value lower than F2.0, such as F1.6.
- The range of focus, an important effect of the aperture, is called the depth of field. The depth of field gets shallower as the aperture is opened, and deeper as the aperture is closed. Use the aperture creatively to obtain the desired effect in your photography.
- This is handy for making the background blurred or sharp.

To adjust the iris automatically

Set the IRIS switch **[B]** or AUTO/MANUAL switch **[F]** to AUTO.

🔍 Notes

- When you set the AUTO/MANUAL switch **[F]** to AUTO, other manually adjusted items (gain, shutter speed, white balance) also become automatic.

Adjusting the volume of light (ND filter)

You can record the subject clearly by using the ND filter **[D]** when the recording environment is too bright. If you do not want to reduce the volume of light, use the ND filter 1. The ND filters 2, 3 and 4 reduce the volume of light to about 1/4, 1/16 and 1/64, respectively.

If the ND icon flashes during the iris automatic adjustment, set the ND filter **[D]** to the position that the icon indicates. The ND icon does not flash during the manual iris adjustment.

🔍 Notes

- If you change the ND filters **[D]** during recording, the movie and sound may be distorted.
- **ND** will flash when your camcorder cannot detect the ND filter positions (1/2/3/4). Check the ND filter position.

Tips

- While recording a bright subject, diffraction may occur if you close the aperture further down, resulting in a fuzzy focus (this is a common phenomenon with video cameras). The ND filter **[D]** suppresses this phenomenon and gives better recording results.

Adjusting the gain

You can adjust the gain manually when you do not want to use the AGC (automatic gain control).

- ① Set the AUTO/MANUAL switch **[F]** to MANUAL during recording or standby.
- ② Set the gain switch **[H]** to H, M or L. The gain value set for the selected gain switch position appears on the screen. You can set the gain value for each gain switch position from [GAIN SETUP] of the  (CAMERA SET) menu (p. 69).

To adjust the gain automatically

Press the GAIN button **[I]**, or set the AUTO/MANUAL switch **[F]** to AUTO.

Notes

- When you set AUTO/MANUAL switch **[F]** to AUTO, other manually adjusted items (iris, shutter speed, white balance) also become automatic.

Adjusting the shutter speed

You can manually adjust and fix the shutter speed. You can make a moving subject look still or emphasize the movement of a moving subject by adjusting the shutter speed.

- ① During recording or standby, set AUTO/MANUAL switch **[F]** to MANUAL.
- ② Press the SHUTTER SPEED button **[E]**.
- ③ Change the shutter speed displayed on the screen by turning the SEL/PUSH EXEC dial **[G]**.
You can adjust the shutter speed in a

range of 1/3 second through 1/10000 second or the extended clear scan

(**[ECS]**).

The denominator of the set shutter speed appears on the screen. For example, [100] appears on the screen when you set the shutter speed to 1/100 second. The larger the value on the screen, the faster the shutter speed.

- ④ Press the SEL/PUSH EXEC dial **[G]** to lock the shutter speed.
To readjust the shutter speed, do steps ② to ④.

Tips

- When recording a subject such as a monitor screen, set the shutter speed in the extended clear scan (**[ECS]**) range in order to obtain images with no horizontal bands of noise. You can set the shutter speed for the extended clear scan from [ECS FREQ.] in the  (CAMERA SET) menu (p. 71).

To adjust the shutter speed automatically

Press the SHUTTER SPEED button **[E]** twice, or set the AUTO/MANUAL switch **[F]** to AUTO.

Notes

- When you set the AUTO/MANUAL switch **[F]** to AUTO, other manually adjusted items (iris, gain, white balance) also become automatic.

Tips

- It is difficult to focus automatically at a lower shutter speed. Manual focusing with your camcorder attached to a tripod is recommended.
- The picture may flicker or change colors under fluorescent lamps, sodium lamps, or mercury lamps. You can reduce flickering by setting the shutter speed to an appropriate frequency in the extended clear scan (**[ECS]**) range ([ECS FREQ.] p. 71).

Changing the settings of your camcorder recordings (Continued)

Adjusting to natural color (White balance)

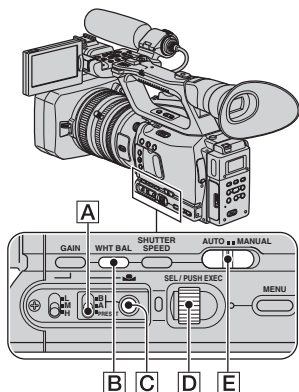

You can adjust and fix the white balance according to the lighting conditions of recording environment. You can store white balance values in memory A (☞ A) and memory B (☞ B), respectively. Unless a white balance is readjusted, values will remain even after the power has been turned off.

1 During recording or standby, set the AUTO/MANUAL switch [E] to MANUAL.

2 Press the WHT BAL button [B].

3 Set the white balance memory switch [A] to any one of PRESET/A/B.

Select A or B for recording with the white balance setting stored in memory A or B. Select PRESET for recording with the white balance setting set in [OUTDOOR], [INDOOR] or [MANU

WB TEMP], which you have selected in [WB PRESET] of the (CAMERA SET) menu.

Indicator	Shooting conditions
A (Memory A)	<ul style="list-style-type: none">White balance values adjusted for light sources can be stored in memory A and memory B. Follow the steps in “To save the adjusted white balance value in memory A or B” (p. 33).
B (Memory B)	
Outdoor ([OUTDOOR])	<ul style="list-style-type: none">Recording sunset/sunrise, just after sunset or just before sunriseRecording neon signs or fireworksUnder daylight color fluorescent lamps
Indoor ([INDOOR])	<ul style="list-style-type: none">Under the lighting conditions that change in many ways, such as a party hallUnder strong light such as in a photography studioUnder sodium lamps or mercury lamps
Color temperature ([MANU WB TEMP])	<ul style="list-style-type: none">Color temperature can be set between 2300K and 15000K (the default setting is 6500K).

Tips

- You can change the outdoor white balance setting by setting offset. Press [C] while (outdoor) is selected and turn the SEL/PUSH EXEC dial [D] to select an offset value from -7 (bluish) to 0 (normal, the default setting) to +7 (reddish). You can also set the white balance offset value from the menu ([WB OUTDR LVL] p. 69).
- You can change the color temperature. Set [WB PRESET] to [MANU WB TEMP] and the white balance memory switch [A] to PRESET, then press the (one push) button [C]. Turn the SEL/PUSH EXEC dial [D] until the desired temperature appears on the screen, then press

the dial to set the temperature. You can also set the color temperature from the menu ([WB TEMP SET] p. 70).

To save the adjusted white balance value in memory A or B

- 1 Set the white balance memory switch to A (👁️ A) or B (👁️ B) in step 3 of “Adjusting to natural color (White balance).”
- 2 Capture a white subject, such as white paper, full-screen in the same lighting condition as the one in which the subject is.
- 3 Press 👁️ (one push) button [C]. 👁️ A or 👁️ B starts flashing rapidly. It will stay on when the white balance adjustment is completed and the adjusted value is stored in 👁️ A or 👁️ B.

To adjust the white balance automatically

Press the WHT BAL button [B] or set the AUTO/MANUAL switch [E] to AUTO.

🔔 Notes

- When you set the AUTO/MANUAL switch [E] to AUTO, other manual adjustments (iris, gain, and shutter speed) also become automatic.

Adjusting the black balance

Normally, you do not need to adjust the black balance. The black balance may become off in some recording conditions. If that happens, adjust the black balance. The adjusted settings are stored only temporarily. The settings return to the default settings when you turn the power off and back on.

- 1 Press the MENU button during standby.

- 2 Select [BLK BALANCE] in the 📷 (CAMERA SET) menu with the SEL/PUSH EXEC dial.

- 3 Select [YES] with the SEL/PUSH EXEC dial.

The black balance adjustment starts. It will take about 15 seconds.

- 4 When [Completed.] appears on the screen, press the MENU button to end this menu.

If the black balance adjustment fails

Check that the iris is closed, then try the adjustment again.

🔔 Notes

- When using a non-Carl Zeiss lens, close the iris prior to the adjustment.

Customizing the picture quality (Picture profile)

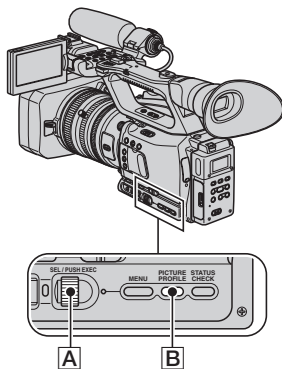

Changing the settings of your camcorder recordings (Continued)

You can customize the picture quality by adjusting picture profile items such as [GAMMA] and [DETAIL].

Connect your camcorder to a TV or monitor, and adjust the picture quality while observing the picture on the TV or monitor screen.

Picture quality settings for different recording conditions are stored in [PP1] through [PP6] as default settings.

🔊 Notes

- When you set [x.v.Color] to [ON], the picture profile will be disabled.

Picture profile number (setting name)	Recording condition
PP1 :USER	Default settings the same as when Picture Profile is [OFF]
PP2 :USER	Default settings the same as when Picture Profile is [OFF]
PP3 :PRO COLOR	Example settings of pictures recorded by a professional shoulder camcorder with ITU709 gamma
PP4 :PD COLOR	Example settings of pictures recorded by a professional handy camcorder with PD gamma
PP5 :FILM LOOK1	Example settings of pictures recorded on cinema color negative film
PP6 :FILM LOOK2	Example settings of pictures screened with cinema color print film

1 During standby, press the PICTURE PROFILE button [B].

2 Select a picture profile number with the SEL/PUSH EXEC dial [A].

You can record with the settings of the selected picture profile.

3 Select [OK] with the SEL/PUSH EXEC dial [A].

To cancel the picture profile recording

Select [OFF] in step 2 with the SEL/PUSH EXEC dial [A].

To change the picture profile

You can change the settings stored in [PP1] through [PP6].

- ① Press the PICTURE PROFILE button [B].
- ② Select the PICTURE PROFILE number with the SEL/PUSH EXEC dial [A].
- ③ Select [SETTING] with the SEL/PUSH EXEC dial [A].
- ④ Select an item to be adjusted with the SEL/PUSH EXEC dial [A].
- ⑤ Adjust the picture quality with the SEL/PUSH EXEC dial [A].
- ⑥ Repeat steps ④ and ⑤ to adjust other items.
- ⑦ Select [↩ RETURN] with the SEL/PUSH EXEC dial [A].
- ⑧ Select [OK] with the SEL/PUSH EXEC dial [A].
A picture profile indicator appears.

💡 Tips

- You can assign picture profiles to the ASSIGN buttons and use them to turn the picture profiles on and off (p. 43).

BLACK LEVEL

To set the black level.

Item	Description and settings
[MASTER BLACK]	Sets the master black level. -15 to +15
[BLACK R]	Sets the black level of Rch. [MASTER BLACK] + [BLACK R] is the black level of Rch. -15 to +15
[BLACK G]	Sets the black level of Gch. [MASTER BLACK] + [BLACK G] is the black level of Gch. -15 to +15
[BLACK B]	Sets the black level of Bch. [MASTER BLACK] + [BLACK B] is the black level of Bch. -15 to +15

GAMMA

To select a gamma curve.

Item	Description and settings
[STANDARD]	Standard gamma curve
[CINEMATONE1]	Gamma curve 1 for producing tone of film camera images
[CINEMATONE2]	Gamma curve 2 for producing tone of film camera images
[ITU709]	Gamma curve that corresponds to ITU-709. Gain in low intensity area: 4.5
[G5.0]	Gamma curve with 5.0 of a low intensity area gain
[PD]	Gamma curve for producing tone similar to DCR-PD series
[x.v.]	Gamma curve similar to x.v.Color

BLACK GAMMA

To correct gamma in low intensity area.

Item	Description and settings
[RANGE]	Selects a correcting range. HIGH / MIDDLE / LOW
[LEVEL]	Sets the correcting level. -7 (maximum black compression) to +7 (maximum black stretch)

Changing the settings of your camcorder recordings (Continued)

KNEE

To set knee point and slope for video signal compression to reduce over-highlighting by limiting signals in high contrast area of the subject to the dynamic range of your camcorder.

Item	Description and settings
[MODE]	Selects a mode either automatic or manual. [AUTO] : to set the knee point and slope automatically. [MANUAL] : to set the knee point and slope manually.
[AUTO SET]	Sets the maximum point and sensitivity in the automatic mode. [MAX POINT] : Sets the maximum point. 90% ~ 100% [SENSITIVITY] : Sets the sensitivity. HIGH/MIDDLE/LOW
[MANUAL SET]	Sets the knee point and slope manually. [POINT] : Sets the knee point. 75% ~ 105% [SLOPE] : Sets the knee slope. -5(gentle) ~ +5(steep)

COLOR MODE

To set type and level of colors.

Item	Description and settings
[TYPE]	Selects a type of colors [STANDARD] : Standard colors [CINEMATONE1] : Film camera image-like colors good with [GAMMA] set to [CINEMATONE1] [CINEMATONE2] : Film camera image-like colors good with [GAMMA] set to [CINEMATONE2] [ITU709 MTX] : Colors corresponding to ITU-709
[LEVEL]	Sets a color level when you set [TYPE] to the settings other than [STANDARD]. 1 (close to color settings of [STANDARD]) - 8 (color settings of the selected type)

COLOR LEVEL

To set the color level.

Item	Description and settings
	-7 (light) to +7 (dark), -8: black and white

COLOR PHASE

To set the color phase.

Item	Description and settings
	-7 (greenish) to +7 (reddish)

COLOR DEPTH

To set the color depth for each color phase.

This function is more effective for deep colors and less effective for light colors. The color looks deeper as you decrease the setting value to more negative side, and lighter as you increase the value to more positive side. This function is effective even if you set [COLOR LEVEL] to [-8] (monotone).

Item	Description and settings
[R]	-7 to +7 (depth of red)
[G]	-7 to +7 (depth of green)
[B]	-7 to +7 (depth of blue)
[C]	-7 to +7 (depth of cyan)
[M]	-7 to +7 (depth of magenta)
[Y]	-7 to +7 (depth of yellow)

COLOR CORRECT

To set items for the color correction.

Item	Description and settings
[TYPE]	<p>Selects color correction type.</p> <p>[OFF] : Not correct colors.</p> <p>[COLOR REVISN] : Corrects colors stored in memory. Colors not stored in memory (displayed in black and white when [COLOR EXTRCT] is set) will not be corrected.</p> <p>[COLOR EXTRCT] : Displays areas in colors that are stored in the memory. The other areas are displayed in black and white. You can use this function to add effects on your movies or to confirm the colors to be stored in the memory.</p>
[MEMORY SEL]	<p>Selects a memory to be effective.</p> <p>[1]: Sets Memory 1 to be effective.</p> <p>[2]: Sets Memory 2 to be effective.</p> <p>[1&2]: Sets both Memory 1 and 2 to be effective.</p>

Changing the settings of your camcorder recordings (Continued)

COLOR CORRCT (Continued)

Item	Description and settings
[MEM1 COLOR]	Sets colors stored in Memory 1. [PHASE] : Sets color phase. 0 (purple) → 8 (red) → 16 (yellow) → 24 (green) → 31 (blue) [RANGE] : Sets color phase range. 0 (no color selection), 1 (narrow: to select only a single color) to 31 (wide: to select multiple colors in similar color phase) [SATURATION] : Sets saturation. 0 (to select from light colors to dark colors) to 31 (to select dark color) [ONE PUSH SET]: Automatically sets [PHASE] for a subject at the center of the marker. [SATURATION] is set to 0.
[MEM1 REVISN]	Corrects colors in Memory 1. [R GAIN] : Corrects the redness of the color in Memory 1. Tone of cyan becomes higher as the redness decreases. -15 (less reddish) to +15 (more reddish) 0 for no correction [B GAIN] : Corrects the blueness of the color in Memory 1. Tone of yellow becomes higher as the blueness decreases. -15 (less bluish) to +15 (more bluish) 0 for no correction
[MEM2 COLOR]	Sets colors stored in Memory 2. See [MEM1 COLOR] for description and settings.
[MEM2 REVISN]	Corrects colors in Memory 2. See [MEM1 REVISN] for description and settings.

WB SHIFT

To set items for the white balance shift.

Item	Description and settings
[FILTER TYPE]	Selects a color filter type for the white balance shift. [LB-CC] : Film type (color conversion and correction) [R-B] : Video type (correction of R and B levels)
[LB[COL TEMP]]	Sets a color temperature offset value. -9 (bluish) to +9 (reddish)
[CC[MG/GR]]	Sets a color correct offset value. -9 (greenish) to +9 (magentish)
[R GAIN]	Sets an R level. -9 (low R level) to +9 (high R level)
[B GAIN]	Sets a B level. -9 (low B level) to +9 (high B level)

DETAIL

To set items for the detail.

Item	Description and settings
[LEVEL]	Sets the detail level. -7 to +7
[MANUAL SET]	[ON/OFF] : Turns on and off the manual detail adjustment. [ON] : Enables the manual detail adjustment (automatic optimization will not be performed). [OFF] : Disables the manual detail adjustment.
[V/H BALANCE]	: Sets the horizontal (H) and vertical (V) balance of detail.
[B/W BALANCE]	: Selects the balance of the upper DETAIL (P) and the lower DETAIL (N). TYPE 1 (off to the lower DETAIL (N) side) to TYPE 5 (off to the upper DETAIL (P) side)
[BLACK LIMIT]	: Sets the limit level of the lower DETAIL (N). 0 (Low limit level: likely to be limited) to 7 (High limit level: not likely to be limited)
[WHITE LIMIT]	: Sets the limit level of the upper DETAIL (P). 0 (Low limit level: likely to be limited) to 7 (High limit level: not likely to be limited)
[CRISPENING]	: Sets the crispening level. 0 (shallow crispening level) to 7 (deep crispening level)
[HI-LIGHT DTL]	: Sets the DETAIL level in the high intensity areas. -2 to +2

Changing the settings of your camcorder recordings (Continued)

SKINTONE DTL

To adjust the detail of skintone areas to reduce wrinkles.

Item	Description and settings
[ON/OFF]	Suppresses details in skin-tone areas to reduce wrinkles. Select [ON] when you want to use this function. You can also select other areas.
[LEVEL]	Sets the adjustment level. 1 (less adjust the detail) to 8 (more adjust the detail)
[COLOR SEL]	Sets color items for the detail adjustment. [PHASE] : Sets the color phase. 0 (purple) → 32 (red) → 64 (yellow) → 96 (green) → 127 (blue) [RANGE] : Sets the color range. 0 (selects no color), 1 (narrow: selects a single color) to 31 (wide: selects multiple colors in similar color phases and saturation) The detail will not be adjusted when you set [RANGE] to 0. [SATURATION] : Sets the color saturation. 0 (selects a light color) to 31 (selects a deep color) [REVERSE] : Reverses the selected color range. If you execute this function when a color has been selected, colors that were not selected will be selected instead. [Y LEVEL] : Sets the color brightness. 0 (selects a dark color) to 31 (selects a bright color) [Y RANGE] : Sets the color brightness range. 1 (narrows the brightness range) to 32 (expands the brightness range) [ONE PUSH SET]: Automatically adjusts [PHASE], [SATURATION] and [Y LEVEL] for a subject at the center of the marker. [RANGE] and [Y RANGE] will not be changed.

PROFILE NAME

To name the picture profiles set in [PP1] through [PP6] (p. 41).

COPY

To copy the settings of the picture profile to another picture profile number.

RESET

To reset the picture profile to the default setting.

To name the picture profile settings

You can name picture profile1 through 6.

- Press the PICTURE PROFILE button **[B]**.
- Select the picture profile that you want to name with the SEL/PUSH EXEC dial **[A]**.
- Select [SETTING] → [PROFILE NAME] with the SEL/PUSH EXEC dial **[A]**.
- Select a letter with the SEL/PUSH EXEC dial **[A]**. Repeat this operation until a complete name is entered.

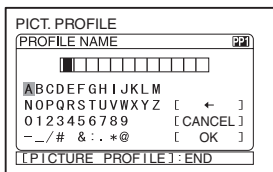

💡 Tips

- Each name can be up to 12 characters long. Characters that can be used in profile names:

- A to Z
- 0 to 9
- - _ / # & : . * @

- Select [OK] with the SEL/PUSH EXEC dial **[A]**.

The profile name is changed.

- Select [↶ RETURN] → [OK] with the SEL/PUSH EXEC dial **[A]**.

To copy the picture profile setting to other picture profiles

- Press the PICTURE PROFILE button **[B]**.
- Select the picture profile that you want to copy from with the SEL/PUSH EXEC dial **[A]**.
- Select [SETTING] → [COPY] with SEL/PUSH EXEC dial **[A]**.

- Select the number of the picture profile that you want to copy to with the SEL/PUSH EXEC dial **[A]**.
- Select [YES] with the SEL/PUSH EXEC dial **[A]**.
- Select [↶ RETURN] → [OK] with the SEL/PUSH EXEC dial **[A]**.

To reset the picture profile settings

You can reset the picture profile settings by each picture profile number. You cannot reset all picture profile settings at once.

- Press the PICTURE PROFILE button **[B]**.
- Select the number of the picture profile that you want to reset with the SEL/PUSH EXEC dial **[A]**.
- Select [SETTING] → [RESET] → [YES] → [↶ RETURN] → [OK] with the SEL/PUSH EXEC dial **[A]**.

Adjusting the volume

You can adjust the volume of a microphone connected to the INPUT1/INPUT2 jack.

💡 Tips

- See page 12 for details on attaching the supplied microphone and on the REC CH SELECT switch.

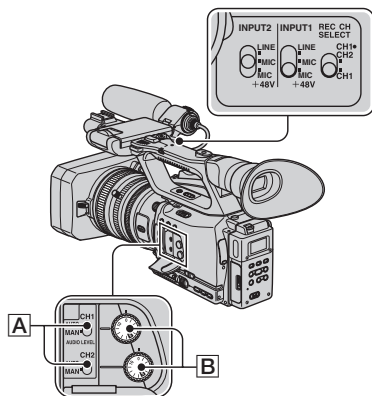

-
- 1** Set the **AUDIO LEVEL** switch (CH1/CH2) **A** of the channel to be adjusted to **MAN**.

♪M appears on the screen.

-
- 2** Turn the **AUDIO LEVEL** dial **B** to adjust the volume during recording or standby.

To restore automatic adjustment

Set the **AUDIO LEVEL** switch (CH1/CH2) **A** of the manually adjusted channel to **AUTO**.

Notes

- When you use a microphone that does not support the MIC+48V, set the INPUT1/INPUT2 switch to MIC. If you use it with the INPUT1/INPUT2 switch set to MIC+48V, it may be damaged or the recorded sound may be distorted.

Tips

- For other settings, see the  (AUDIO SET) menu (p. 76).

Assigning the functions to the ASSIGN buttons

Some functions need to be assigned to the ASSIGN buttons for use. You can assign a single function to any one of the ASSIGN 1 to 6 buttons on the body or the L1, L2 and RET buttons on the lens.

🔊 Notes

- The following functions cannot be assigned to the RET button.
 - FOCUS (for changing between automatic focus and manual focus)
 - ONE PUSH AF
 - FOCUS INFNTY
 - FOCUS MACRO
 - STEADYSHOT

💡 Tips

- The RET button is an assignable button on non-Carl Zeiss lenses.

Functions you can assign to the ASSIGN buttons

The buttons in parentheses indicate that the functions are assigned to the buttons by default.

- FOCUS (p. 28)
- EXP.FOCUS (p. 29) (L2 button)
- ONE PUSH AF (p. 29)
- FOCUS INFNTY (p. 29)
- FOCUS MACRO (p. 72)
- D.EXTENDER (p. 72) (L1 button)
- HYPER GAIN (p. 69)
- BLK BALANCE (p. 33)
- AE SHIFT (p. 70) (ASSIGN 5 button)
- INDEX MARK (p. 44)
- STEADYSHOT (p. 72)
- BACK LIGHT (p. 71)
- SPOTLIGHT (p. 71)
- FADER (p. 72)
- COLOR BAR (p. 75)
- LAST SCN RVW (p. 45)
- REC REVIEW (p. 45) (ASSIGN 6 button/RET button)
- END SEARCH (p. 45)
- ZEBRA (p. 79) (ASSIGN 4 button)
- MARKER (p. 80)
- PEAKING (p. 79)
- DISPLAY (p. 53)

- TC RESET (p. 87)
- TC COUNTUP (p. 87)
- PHOTO (p. 26)
- REC LAMP[F] (p. 92)
- REC LAMP[R] (p. 92)
- PICTURE PROFILE (p. 33)

L1 button ASSIGN 4-6 buttons

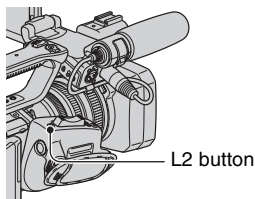
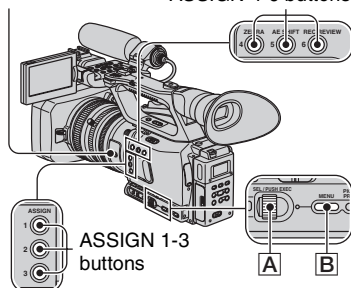

1 Press the MENU button **[B]**.

2 Select the **[OTHERS]** → **[ASSIGN BTN]** with the SEL/PUSH EXEC dial **[A]**.

3 Select **[CAMERA]** or **[LENS]**, whichever the ASSIGN button to which you want to assign a function is located, with the SEL/PUSH EXEC dial **[A]**.

4 Select the ASSIGN button to which you want to assign a function with the SEL/PUSH EXEC dial .

- You can select the ASSIGN 1 through 6 buttons on the body and the L1, L2 and RET button on the lens.
- [-----] appears if no function is assigned to the ASSIGN button.

5 Select the function that you want to assign with the SEL/PUSH EXEC dial .

6 Select [OK] with the SEL/PUSH EXEC dial .

7 Select [RETURN] with the SEL/PUSH EXEC dial .

8 Press the MENU button  to hide the menu screen.

Recording an index signal

If you record a scene with an index signal, you can easily find that scene during playback (p. 55).

The index function will make it easier to check the transition of recording or edit your pictures using index signals.

1 Assign [INDEX MARK] to one of the ASSIGN buttons (p. 43).

2 Press the ASSIGN button to which [INDEX MARK] is assigned.

During recording

 appears for about 7 seconds and an index signal is recorded.

During standby

 flashes.

After you press the REC START/STOP button to start recording,  appears for about 7 seconds and an index signal is recorded.

To cancel the operation

Press the ASSIGN button to which [INDEX MARK] is assigned again before you start recording.

Notes

- You cannot record an index signal on a recorded tape afterward.

Reviewing the most recently recorded scenes (Rec review)

You can view about 2 seconds of the scene recorded just before you stopped the tape. This is convenient during playback of the latest scene check.

Press the REC REVIEW button or the ASSIGN button to which [REC REVIEW] is assigned during standby.

The last 2 seconds (approx.) of the most recently recorded scenes will be played back, then your camcorder returns to standby.

Searching for the last scene of the most recent recording (End search)

1 Assign [END SEARCH] to one of the ASSIGN buttons (p. 43).

2 Press the ASSIGN button to which [END SEARCH] is assigned.

The last scene of the most recent recording will be played back for about 5 seconds, and the camcorder goes standby at the point where the last recording has finished.

Notes

- End search will not work once you eject the tape.

- End search will not work correctly if a blank section exists between recorded sections on the tape.

Playing back the most recently recorded movies (Last scene review)

You can set your camcorder to automatically rewind the tape to the beginning of the most recently recorded scene, play back to the end of the scene, then stop the tape.

1 Assign [LAST SCN RVW] to an ASSIGN button (p. 43).

2 During standby, press the ASSIGN button to which [LAST SCN RVW] is assigned.

The last scene review starts.

Notes

- If the recording time of the movie is short, [LAST SCN RVW] may not work correctly.

Tips

- If you press the ASSIGN button again during the last scene review, your camcorder plays back the last 5 seconds of the most recently recorded movie, then goes standby at the end of the recording.

Using the Shot transition

You can store settings of focus, zoom, iris, gain, shutter speed and white balance, and smoothly shift from the current settings to the stored settings (shot transition).

For example, you can shift the focus from closer objects to farther objects, or change the depth of field by adjusting the iris. You can also develop scenes under different conditions smoothly. If you store manually adjusted settings of white balance, you can smoothly shift from one scene to another under different conditions, such as from indoor to outdoor.

Sony recommends that you use a tripod to avoid image blurring.

You can set the following items in [SHOT TRANSITION] of the  (CAMERA SET) menu (p. 74).

Item	Description and settings
TRANS TIME	Setting of transition time (the default setting is [4.0sec]) You can set the transition time by 0.5 sec between [3.5sec] and [15.0sec], or select from [20sec], [30sec], [45sec] and [60sec].
START TIMER	Setting of timer to start shot transition (the default setting is [OFF]) You can select from [5sec], [10sec] and [20sec].

Item	Description and settings
REC LINK	Setting of transition linked with start of recording (the default setting is [OFF]) [OFF]: Not to start transition when the recording is started. [SHOT-A]: To start transition to the SHOT-A when the recording is started. [SHOT-B]: To start transition to the SHOT-B when the recording is started.
FOCUS TRANS	Setting ([ON]/[OFF]) of focus transition (the default setting is [ON])
ZOOM TRANS	Setting ([ON]/[OFF]) of zoom transition (the default setting is [ON])
IRIS TRANS	Setting ([ON]/[OFF]) of iris transition (the default setting is [ON])

🔊 Notes

- You cannot manually adjust the focus, zoom, iris, gain, shutter speed and white balance while the CHECK or EXEC lamp is on. You can manually adjust the focus, zoom and iris, even the CHECK or EXEC lamp is on when you set [FOCUS TRANS], [ZOOM TRANS] and [IRIS TRANS] to [OFF], respectively.
- When [EXT REC CTRL] is set to [EXT ONLY], setting [REC LINK] (linked recording) to [SHOT-A] or [SHOT-B] links the start of transition to the start of recording on an external device (HVR-MRC1 or HVR-DR60).

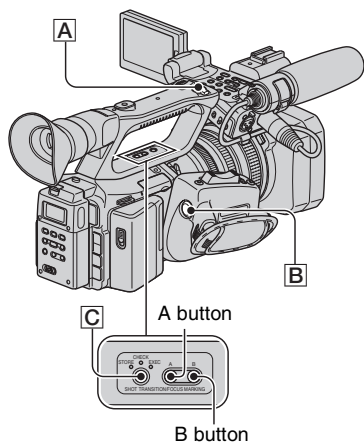

1 Set [S.TRANS/F.MARK] of the (CAMERA SET) menu to [SHOT TRANSITION].

2 Press the SHOT TRANSITION/ FOCUS MARKING button **C** to bring up the shot transition store screen.

The STORE lamp turns on.

3 Press the **A** button to store the settings in SHOT-A, or the **B** button to store the settings in SHOT-B.

Notes

- The settings stored in SHOT-A or SHOT-B will be erased when you set the POWER switch to OFF.

4 Press the SHOT TRANSITION/ FOCUS MARKING button **C** again to bring up the shot transition check screen.

The CHECK lamp turns on.

Press the **A** button to check SHOT-A, or the **B** button to check SHOT-B. The image will be displayed with the settings stored in the selected SHOT. The focus, zoom, iris, gain, shutter speed and white balance are automatically adjusted to the stored settings.

Notes

- The settings do not shift to the stored settings with the transition time set in [TRANS TIME] (p. 46).

5 Press SHOT TRANSITION/FOCUS MARKING button **C** again to bring up the shot transition execution screen.

The EXEC lamp turns on.

6 Press the REC START/STOP button **A** (or **B**).

Press the **A** button for recording with SHOT-A, or the **B** button for recording with SHOT-B.

The settings shift from the current ones to the stored ones.

Notes

- When you change [SHOT TRANSITION] (p. 46), press the SHOT TRANSITION/FOCUS MARKING button repeatedly to exit the shot transition screen.
- You cannot return from the stored SHOT-A or SHOT-B settings to previous settings after you execute the shot transition during recording.

Using the Shot transition (Continued)

- If you press the following buttons during the shot transition operation, the operation will be canceled:
 - PICTURE PROFILE
 - MENU
 - STATUS CHECK
 - EXPANDED FOCUS
- You can also make a transition from the SHOT-A to the SHOT-B or from the SHOT-B to the SHOT-A. For example, to make a transition from the SHOT-A to the SHOT-B, display the shot transition check screen, press the A button to bring up the SHOT-A and press the REC START/STOP button. Then, display the shot transition execution screen and press the B button.
- You can rehearse the shot transition by pressing the respective buttons (A or B) to which your customized settings are assigned before pressing the REC START/STOP button in step 6.
- The settings stored in the memory (SHOT-A/SHOT-B) are cleared when you remove the Carl Zeiss lens, or you adjust the flange focal length.

To cancel the operation

Press the SHOT TRANSITION/FOCUS MARKING button  repeatedly to exit the shot transition screen.

Marking focal point on the screen (Focus marking)

You can mark a focal point, at which you set a subject in focus, on the LCD screen prior to the recording. You can use this function during the manual focus.

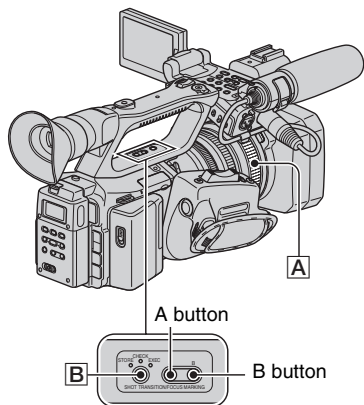

button for marking a focal point at position B.

When you press the A button, ▼ and A appear on the focus marking bar. When you press the B button, ▲ and B appear on the focus marking bar.

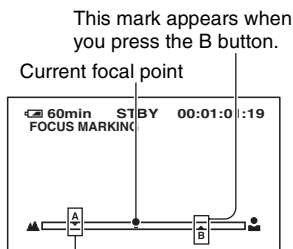

This mark appears when you press the A button.

1 Set [S.TRANS/F.MARK] of the  (CAMERA SET) menu to [FOCUS MARKING].

2 Press the SHOT TRANSITION/ FOCUS MARKING button .

The focus marking bar appears at the bottom of the screen.

3 Adjust the focus by turning the focus ring  and set a focal point.

A cursor on the focus marking bar moves as you turn the focus ring.

4 Press the A button for marking a focal point at position A or the B

The color of the marks changes when position A or B matches the current focal point.

Notes

- The focus marking function does not work when [FOCUS MACRO] is set to [ON].
- You cannot use the focus marking when you use a non-Carl Zeiss lens. Marking positions A and B will be cleared when you dismount the lens or turn off the power.

Tips

- You can use the focus marking function during the expanded focus.

Playback

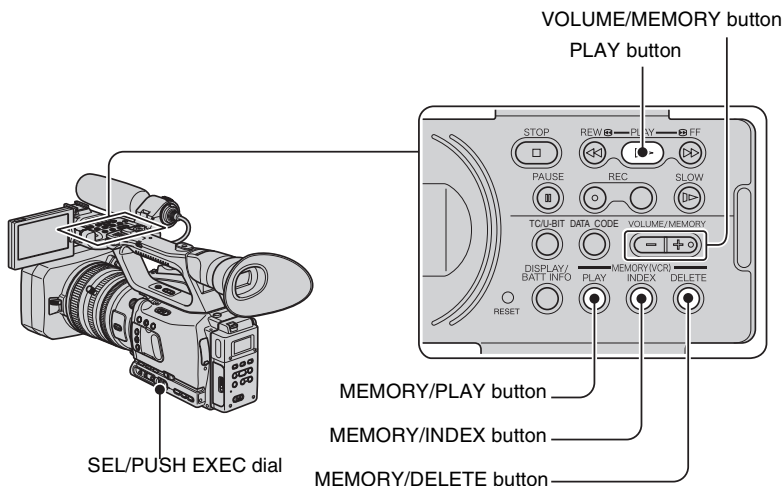

You can play back movies as follows:

1 Slide the POWER switch to VCR while pressing the green button.

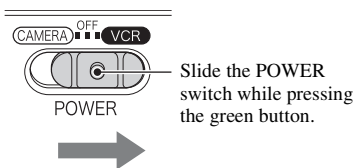

2 Start playing back.

Press ◀ (rewind) to go to the point you want to view, then press ▶ (play) to start playback.

- ■ : STOP
- || : PAUSE (Press ▶ or || again to restart the playback)
- ◀◀ : REW ◀ (Rewind, review)
- ▶▶ : ▶▶ FF (Cue, fast forward)
- ▶▶ : SLOW

⚡ Notes

- Your camcorder automatically goes into a stopped state when it is in pause for more than 3 minutes.
- The screen may temporarily go blank losing images and sound when signals switch between HDV and DVCAM (DV) during playback of a tape in which HDV format and DVCAM (DV) format are mixed.

- You cannot play back movies recorded in HDV format on DVCAM (DV) format video cameras or mini DV players.
- You can play back a DV format tape on your camcorder only when its contents are recorded in the SP mode. You cannot play back movies recorded on the DV format tape in the LP mode.
- Time code and user bits will not be displayed correctly when you play back a tape with no time code or user bit data, or a tape with time code that your camcorder does not support.

💡 Tips

- See page 139 for indicators displayed on the screen during playback.
- See page 53 for how to switch displays during playback.

To search for a scene while viewing a movie

Press and hold ◀◀/▶▶ during playback (Picture Search). To view during fast forward, press and hold ▶▶. To view during rewind, press and hold ◀◀ (Skip Scan).

To adjust the volume

Adjust the volume with the VOLUME/MEMORY button.

To view still images

- ① Set the POWER switch to VCR.
- ② Press the MEMORY/PLAY button.
- ③ Select still image that you want to view using the VOLUME/MEMORY button.
To stop viewing still images, press the MEMORY/PLAY button again.

To display the list of still images (index screen)

- ① Set the POWER switch to VCR.
- ② Press the MEMORY/INDEX button.

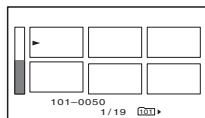

- ③ Select a still image using the VOLUME/MEMORY button.
To display a single image, move ▶ to that image and press the MEMORY/PLAY button.
To stop displaying the list of still images, press the MEMORY/INDEX button again.

To delete still images from the “Memory Stick Duo”



- ① Do the steps of “To view still images” to display still images that you want to delete.
- ② Press the MEMORY/DELETE button.
- ③ Select [YES] with the SEL/PUSH EXEC dial.
The still image will be deleted.

Playback (Continued)

Notes

- Still images cannot be restored once you delete them.
- You cannot delete still images when the “Memory Stick Duo” is write-protected (p. 119) or the still image is protected (p. 104).

Tips

- To delete a still image in the index, move  to the still image using the VOLUME/MEMORY button, then do steps ② and ③.
- To delete all still images, do [ ALL ERASE] of the  (MEMORY SET) menu (p. 89).

Changing/checking the settings in your camcorder

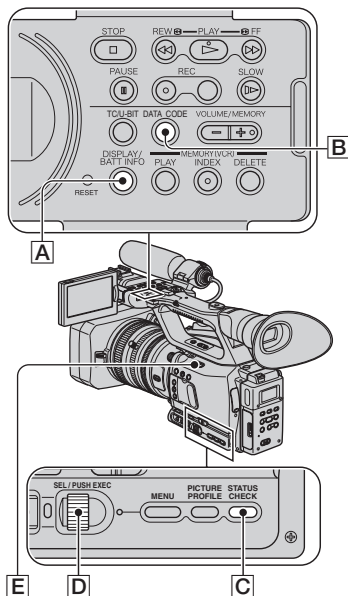

Changing the screen

You can turn on and off the display of the time code, tape counter, and other information on the screen.

Press the **DISPLAY/BATT INFO** button **A**.

The screen indicators turn on (displayed) and off (not displayed) as you press the button.

When the POWER switch is set to CAMERA, the screen changes (detailed display → simple display → no display) as you press the button.

💡 Tips

- You can display the screen indicators during playback on a TV. Select [V-OUT/PANEL] of [DISP OUTPUT] (p. 83).

- When you assign [DISPLAY] of [ASSIGN BTN] to an ASSIGN button, you can use the ASSIGN button to change the screen.

Displaying recording data (Data code)

You can display information, including date, time and camera data, automatically stored during recording on the screen during playback.

1 Set the POWER switch **E** to VCR.

2 Press the DATA CODE button **B** during playback or pause.

The screen changes (date and time display → camera data display → no display) as you press the button.

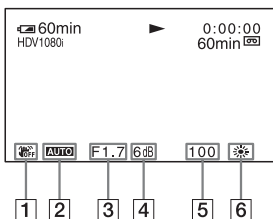

1 SteadyShot off

2 Exposure

AUTO appears during playback of the movie recorded with the iris, gain and shutter speed automatically adjusted.

MANUAL appears during playback of the movie recorded with the iris, gain and shutter speed manually adjusted.

Changing/checking the settings in your camcorder (Continued)

3 Iris

CLOSE appears in the iris value display area during playback of the movie recorded with the iris manually adjusted to its maximum value.

4 Gain

5 Shutter speed

6 White balance

PWB appears during playback of the movie recorded with the shot transition or [MANU WB TEMP].

Notes

- The exposure correction value (0EV), shutter speed and iris will be displayed during viewing of still images on "Memory Stick Duo."
- Date and time will be displayed in the same area when you select the date and time display. If you record without setting date and time, [-- -- ----] and [--:--:--] will be displayed.
- An accurate shutter speed may not be displayed when you play back a tape recorded with your camcorder on another device. Check the data code that is displayed on the screen when you play back the tape on your camcorder for the accurate shutter speed.
- A shutter speed is indicated with [---] during playback of the movie recorded with the extended clear scan (**ECS**).

Displaying the settings in your camcorder (Status check)

You can check the settings of the following items.

- Audio setup such as microphone volume level (p. 76)
- Output signal setup ([VCR HDV/DV], etc.) (p. 83)
- Functions assigned to the ASSIGN buttons (p. 43)
- Camera setup (p. 69)
- External devices

1 Press the STATUS CHECK button **C**.

2 Turn the SEL/PUSH EXEC dial **D** until a desired display shows up on the screen.

When the POWER switch **E** is set to CAMERA, the display changes in the following sequence:

AUDIO → OUTPUT → ASSIGN → CAMERA → EXT DEVICE (when an external device is connected)

When the POWER switch **E** is set to VCR, the display changes in the following sequence:

AUDIO → OUTPUT → ASSIGN → EXT DEVICE (when an external device is connected)

To hide the display

- Press the STATUS CHECK button **C**.

Checking the remaining battery (Battery Info)

Set the POWER switch **E** to OFF, then press the DISPLAY/BATT INFO button **A**. The approximate recordable time in the selected format and battery information appear for about 7 seconds. You can view the battery information for up to 20 seconds by pressing the button again while the information is displayed.

Remaining battery (approx.)

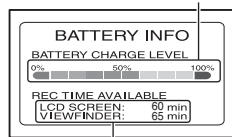

Recording capacity (approx.)

Locating a scene on a tape

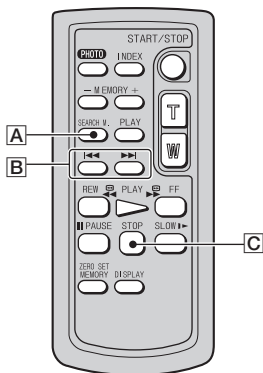

Notes

- See page 136 for details on how to use the Remote Commander.

Searching for a scene by date of recording (Date search)

You can search scenes by recording dates.

1 Set the POWER switch to VCR.

2 Press the SEARCH M. button **A** on the Remote Commander repeatedly to select [DATE SEARCH].

3 Press the I◀◀ (previous)/▶▶I (next) button **B** on the Remote Commander to select a recording date.

You can select a date previous or next to the date of the current tape position. Playback automatically starts from the scene recorded on the selected date.

To cancel the operation

Press the STOP button **C** on the Remote Commander.

Notes

- Each day of recording must be longer than 2 minutes. Your camcorder may not detect the date if the recording of that date is short.
- The date search may not work properly if a blank section exists on the tape.

Searching for a recording start point (Index search)

You can search scenes by indexes recorded at the start of recording (p. 44).

1 Set the POWER switch to VCR.

2 Press the SEARCH M. button **A** on the Remote Commander repeatedly to select [INDEX SEARCH].

3 Press the I◀◀ (previous)/▶▶I (next) button **B** on the Remote Commander to select an index point.

You can select an index previous or next to the index of the current tape position. Playback automatically starts from the scene marked by the index.

Locating a scene on a tape (Continued)

To cancel the operation

Press the STOP button  on the Remote Commander.

Notes

- Recording between indexes must be longer than 2 minutes. Your camcorder may not detect the date if the recording between the indexes is short.
- The index search may not work properly if a blank section exists on the tape.

Playing the picture on a TV

Connection methods and image quality differ depending on what type of TV is connected and connectors used.

Use the supplied AC Adaptor/Charger to obtain AC power (p. 14).

Refer also to the instruction manuals supplied with the device to be connected.

Jacks on your camcorder

Open the jack cover and connect the cable.

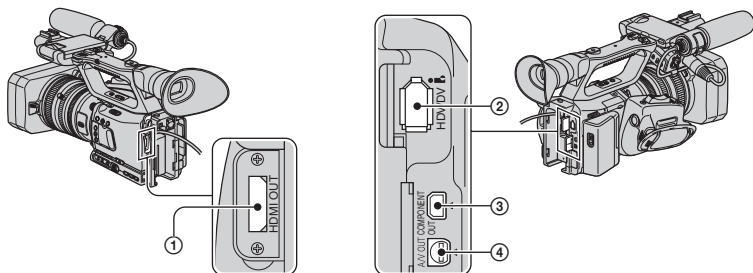

Notes

- Set all the necessary menu items before you connect your camcorder to a TV. If you change the settings of [VCR HDV/DV] or [i.LINK SET] after connecting your camcorder to the TV with an i.LINK cable, the TV may not recognize video signals properly.

Connecting to a high definition TV

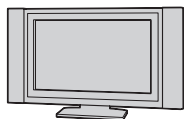

A movie recorded in HD quality is played back in HD quality.
A movie recorded in SD quality is played back in SD quality.

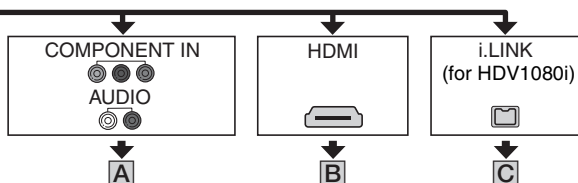

Playing the picture on a TV (Continued)

↔: Signal flow, (): Reference pages

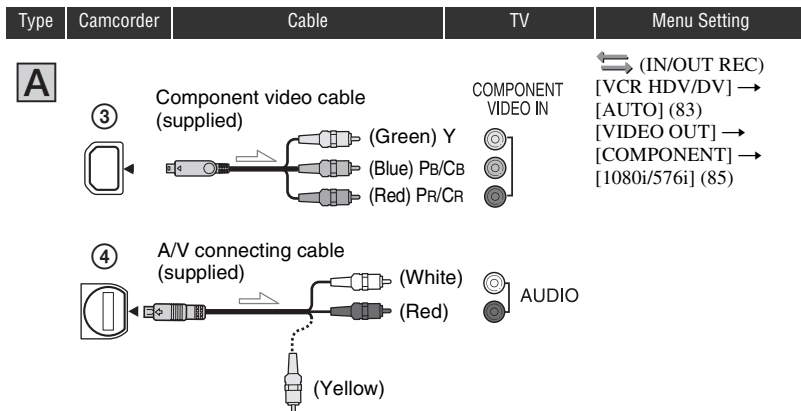

Notes

- When you only connect a component video cable, audio signals are not outputted. An A/V connecting cable is also needed to output audio signals. Connect the white and red plugs of the A/V connecting cable to the audio input jack of your TV.

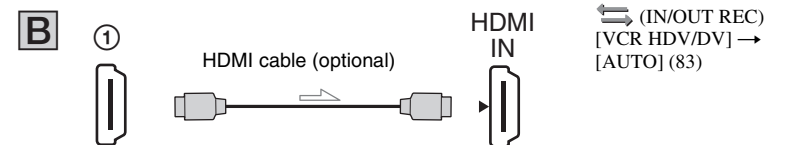







Notes

- Use an HDMI cable with the HDMI logo.
- Pictures in the DVCAM (DV) format are not output from the HDMI OUT jack, if copyright protection signals are recorded in the pictures.
- DVCAM (DV) format pictures input to the camcorder via i.LINK cable (p. 98) cannot be output.
- Your TVs may not function correctly (for example, no sound or image). Do not connect the HDMI OUT jack of your camcorder and HDMI OUT jack of the external device with the HDMI cable. This may cause a malfunction.

Tips

- HDMI (High-Definition Multimedia Interface) is an interface to send both video and audio signals. Connecting HDMI OUT jack to an external device supplies high quality images and digital audio to you.

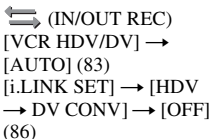
 : Signal flow, () : Reference pages

Type	Camcorder	Cable	TV	Menu Setting
				 <p>  (IN/OUT REC) [VCR HDV/DV] → [AUTO] (83) [i.LINK SET] → [HDV] → DV CONV] → [OFF] (86) </p>

Notes

- **Your TV needs to have an i.LINK jack compatible with HDV1080i. For details, confirm the specifications of your TV.**
- If your TV is not compatible with HDV1080i, connect your camcorder and TV with the supplied component video cable and A/V connecting cable as illustrated in **A**.
- The TV needs to be set so that it recognizes that the camcorder is connected. Refer to the instruction manuals supplied with your TV.
- This camcorder has a 6-pin i.LINK terminal. Select a cable that fits the terminal on the TV to be attached.

Playing the picture on a TV (Continued)

Connecting to a 16:9 (wide) or 4:3 TV

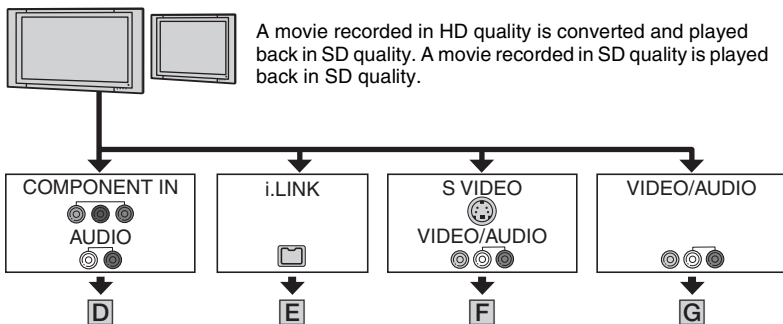

To set the aspect ratio according to the connected TV (16:9/4:3)

Set the down-convert setting as follows:

For HDV format signals:

⇄ (IN/OUT REC) menu → [VIDEO OUT] → [DOWN CONVERT]

For DV format signals:

⇄ (IN/OUT REC) menu → [VIDEO OUT] → [DV WIDE CONV]

💡 Tips

- When your TV is monaural (When your TV has only one audio input jack), connect the yellow plug of the A/V connecting cable to the video input jack and connect the white (left channel) or the red (right channel) plug to the audio input jack of your TV or VCR. When you want to play back the sound in monaural mode, use a connecting cable for that purpose.

↔ : Signal flow, () : Reference pages

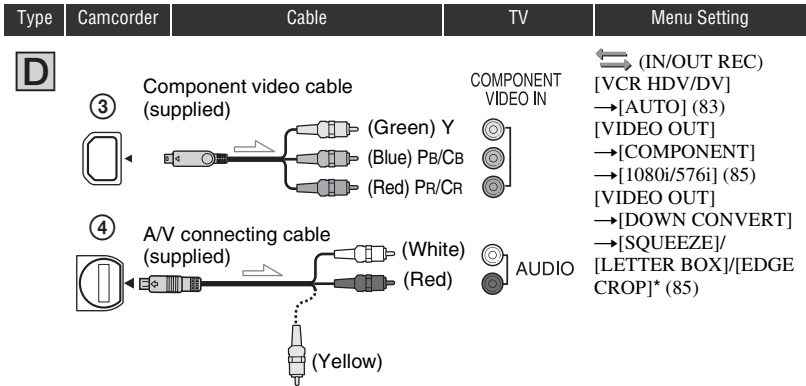

⚙ Notes

- When you only connect a component video cable, audio signals are not outputted. An A/V connecting cable is also needed to output audio signals. Connect the white and red plugs of the A/V connecting cable to the audio input jack of your TV.

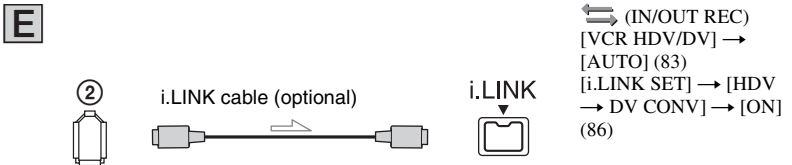









⚙ Notes

- The TV needs to be set so that it recognizes that the camcorder is connected. Refer to the instruction manuals supplied with your TV.
- This camcorder has a 6-pin i.LINK terminal. Select a cable that fits the terminal on the TV to be attached.

* Change the settings according to the TV connected.

Playing the picture on a TV (Continued)

↔ : Signal flow, () : Reference pages

Type	Camcorder	Cable	TV	Menu Setting
F		A/V connecting cable with S VIDEO (optional)	 S VIDEO  (White)  (Red)	↔ (IN/OUT REC) [VCR HDV/DV] → [AUTO] (83) [VIDEO OUT] → [DOWN CONVERT] → [SQUEEZE]/[LETTER BOX]/[EDGE CROP]* (85)
G		A/V connecting cable (supplied)	 S VIDEO  (Yellow)  (White)  (Red)	↔ (IN/OUT REC) [VCR HDV/DV] → [AUTO] (83) [VIDEO OUT] → [DOWN CONVERT] → [SQUEEZE]/[LETTER BOX]/[EDGE CROP]* (85)

* Change the settings according to the TV connected.

Notes

- If you connect your camcorder to the TV using more than one type of cable to output images, the order of priority of the TV input jacks is as follows:
HDMI → component video → S VIDEO → video.
- See page 121 for the details of i.LINK.

When connecting to your TV via a VCR

Select the connecting method on page 94 depending on the input jack of the VCR. Connect your camcorder to the LINE IN input on the VCR using the A/V connecting cable. Set the input selector on the VCR to LINE (VIDEO 1, VIDEO 2, etc.).

If your TV/VCR has a 21-pin adaptor (EUROCONNECTOR)

Use a 21-pin adaptor (optional) to view playback pictures.

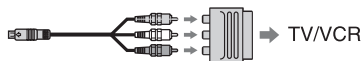

Using the menu items

You can change various settings or make detailed adjustments using the menu items displayed on the screen.

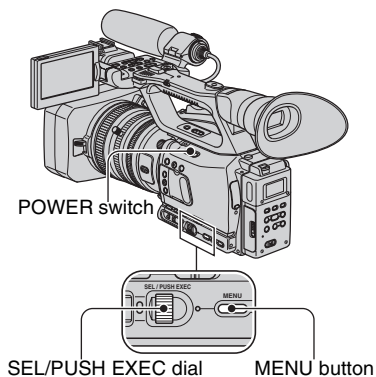





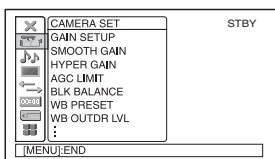

1 Set the **POWER** switch to **CAMERA** or **VCR**.

2 Press the **MENU** button.

The menu index screen appears.



3 Turn the **SEL/PUSH EXEC** dial until the icon of the desired menu is highlighted, then press the dial to select the menu.

-  CAMERA SET (p. 69)
-  AUDIO SET (p. 76)
-  DISPLAY SET (p. 79)
-  IN/OUT REC (p. 83)
-  TC/UB SET (p. 87)
-  MEMORY SET (p. 89)
-  OTHERS (p. 90)

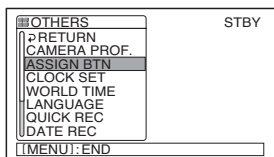

4 Turn the **SEL/PUSH EXEC** dial until the desired menu item is highlighted, then press the dial to select the item.

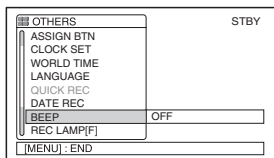

The available menu items vary depending on the position of the power switch of your camcorder. Unavailable items will be grayed out.

-
- 5** Turn the SEL/PUSH EXEC dial until the desired setting is highlighted or to bring up the desired setting, then press the dial to confirm the setting.

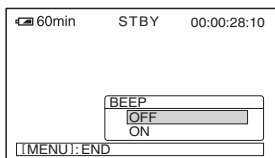

-
- 6** Press the MENU button to hide the menu screen.

To return to the previous screen, select [↩ RETURN].

Menu items

Available menu items (●) vary depending on the POWER switch position.

Position of POWER switch:

CAMERA

VCR



(CAMERA SET) menu (p. 69)

GAIN SETUP	●	—
SMOOTH GAIN	●	—
HYPER GAIN (AS)	●	—
AGC LIMIT	●	—
BLK BALANCE (AS)	●	—
WB PRESET	●	—
WB OUTDR LVL	●	—
WB TEMP SET	●	—
ATW SENS	●	—
SMOOTH WB	●	—
AE SHIFT (AS)	●	—
AE WINDOW	●	—
AE RESPONSE	●	—
AT IRIS LMT	●	—
ECS FREQ.	●	—
FLCKR REDUCE	●	—
CNTRST ENHCR	●	—
BACK LIGHT (AS)	●	—
SPOTLIGHT (AS)	●	—
STEADYSHOT (AS)	●	—
AF ASSIST	●	—
FOCUS MACRO (AS)	●	—
HANDLE ZOOM	●	—
D.EXTENDER (AS)	●	—
FADER (AS)	●	—
SMTH SLW REC	●	—
INTERVAL REC	●	—
DV FRAME REC (DVCAM) (DV) (2)	●	—
SHOT TRANSITION	●	—
S.TRANS/F.MARK	●	—
x.v.Color (HDV1080)	●	—
COLOR BAR (AS)	●	—
FLANGE BACK	●	—



(AUDIO SET) menu (p. 76)

DV AU.MODE (DVCAM) (DV) (2)	●	—
AUDIO LIMIT	●	—
XLR SET	●	—
AUDIO CH SEL	—	●
DV AUDIO MIX (DVCAM) (DV) (2)	—	●

Position of POWER switch:

CAMERA

VCR

**(DISPLAY SET) menu (p. 79)**

	CAMERA	VCR
ZEBRA (AS)	●	-
HISTOGRAM	●	-
PEAKING (AS)	●	-
MARKER (AS)	●	-
CAM LEVELING	●	-
EXP.FOCUS TYPE	●	-
CAM DATA DSP	●	-
AU.LVL DISP	●	-
ZOOM DISPLAY	●	-
FOCUS DISP	●	-
SHUTTER DISP	●	-
LCD BRIGHT	●	●
LCD COLOR	●	●
LCD BL LEVEL	●	●
VF B.LIGHT	●	●
VF COLOR	●	●
VF POWERMODE	●	●
LETTER SIZE	●	●
REMAINING	●	●
DISP OUTPUT	●	●

**(IN/OUT REC) menu (p. 83)**

REC FORMAT	●	-
VCR HDV/DV	-	●
HDV PROGRE.	●	-
DV PROGRE.	●	-
DV REC MODE	●	●
DV WIDE REC	●	-
VIDEO OUT	●	●
i.LINK SET	●	●
EXT REC CTRL	●	-

00-00

(TC/UB SET) menu (p. 87)

TC PRESET	●	●
TC COUNTUP (AS)	●	●
UB PRESET	●	●
TC RUN	●	●
TC MAKE	●	●
TC LINK	●	-
UB TIME REC	●	●
UB-DATE/TC-TIME	●	●

Continued →

Menu items (Continued)

Position of POWER switch:



CAMERA

VCR

(MEMORY SET) menu (p. 89)

	CAMERA	VCR
 ALL ERASE	—	●
 FORMAT	●	●
FILE NO.	●	●
NEW FOLDER	●	●
REC FOLDER	●	●
PB FOLDER	—	●

(OTHERS) (p. 90)

CAMERA PROF.	●	●
ASSIGN BTN	●	●
CLOCK SET	●	●
WORLD TIME	●	●
LANGUAGE	●	●
PB ZOOM	—	●
QUICK REC 	●	—
DATE REC	●	—
BEEP	●	●
REC LAMP[F] 	●	—
REC LAMP[R] 	●	—
REMOTE CTRL	●	●
HOURS METER	●	●

(CAMERA SET) menu

Settings to adjust your camcorder to the recording conditions (GAIN SETUP/BACK LIGHT/STEADYSHOT, etc.)

The default settings are marked with ►.
The indicators in parentheses appear when the items are selected.

See page 64 for details on selecting menu items.

Press the MENU button → select the  (CAMERA SET) with the SEL/PUSH EXEC dial.

GAIN SETUP

You can set gain values for H, M and L positions of the GAIN switch. The default settings of [H], [M] and [L] are 18dB, 9dB and 0dB, respectively.

- ① Select [H], [M] or [L] with the SEL/PUSH EXEC dial.
- ② Set the gain value with the SEL/PUSH EXEC dial, and press the dial.
You can select the value between -6dB and 21dB by 3dB. The larger the value, the higher the gain.
- ③ Select [OK] with the SEL/PUSH EXEC dial.
- ④ Press the MENU button to hide the menu screen.

SMOOTH GAIN

You can set the transition speed at which the gain setting shifts from one value to another, set for the gain switch positions, when you switch the gain switch from a position to another. You can select the transition speed from [FAST], [MIDDLE] and [SLOW] or set to [OFF]. The default setting is [OFF].

HYPER GAIN (AS)

When you set this function to [ON] (HYPER), you can increase the gain to its limit. The default setting is [OFF].

Notes

- During the hyper gain, you cannot use the following function.
 - [BACK LIGHT]
 - [SPOTLIGHT]
- During the hyper gain, the picture quality will be reduced due to noise.
- [HYPER GAIN] is automatically set to [OFF] if you turn the power off and back on.

Tips

- You are recommended to use this function with manual focus.

AGC LIMIT

You can select the upper limit for the Auto Gain Control (AGC) from [OFF] (21dB, the default setting), [18dB], [15dB], [12dB], [9dB], [6dB], [3dB] and [0dB].

Notes

- If you adjust the gain manually, you cannot obtain the effect of [AGC LIMIT].

BLK BALANCE (AS)

See page 33.

WB PRESET

You can use the preset white balance. For more details, see page 32.

WB OUTDR LVL

You can set an offset value to adjust the outdoor white balance when you set [WB PRESET] to [OUTDOOR]. You can select the offset value from [-7] (bluish) - [0] (normal) - [+7] (reddish). The default setting is [0].

Press the MENU button → select the  (CAMERA SET) with the SEL/PUSH EXEC dial.

WB TEMP SET

You can set the color temperature between 2300K and 15000K in 100K steps when you set [WB PRESET] to [MANU WB TEMP].

ATW SENS

You can set the auto white balance operation under a reddish light source such as an incandescent lamp or candle, or under a blueish light source such as in outdoor shade.

► INTELLIGENT

Automatically adjusts the white balance so that scenes look natural for the light source.

HIGH

Automatically adjusts the white balance while reducing redness or blueness.

MIDDLE

LOW

Automatically adjusts the white balance while increasing redness or blueness.

🔌 Notes

- This is only effective when white balance is adjusted automatically.
- [ATW SENS] is not effective under a clear sky or the sun.

SMOOTH WB

You can set the transition speed at which the color temperature values shifts from one value to another, set for the white balance memory switch positions, when you switch the white balance memory switch from a position to another. You can select the transition speed from [FAST], [MIDDLE] and [SLOW] or set to [OFF]. The default setting is [OFF].

AE SHIFT

You can set an offset value to adjust the automatic exposure adjustment value between [-7] (dark) and [+7] (bright) with the SEL/PUSH EXEC dial. The default setting is [0].  and selected value appears on the screen when you change the value from the default setting.

🔌 Notes

- This function is not effective while you adjust the iris, shutter speed and gain all manually.
- This function is not effective when [HYPER GAIN] is set to [ON].

AE WINDOW

You can select a photometric area in which the automatic exposure adjustment function detects changes in the brightness of the subject to automatically adjust the exposure. This function is not effective during the manual exposure adjustment.

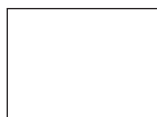

STANDARD

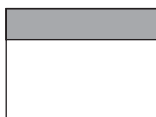

TYPE 1

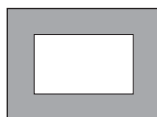

TYPE 2

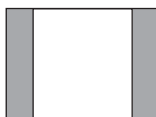

TYPE 3

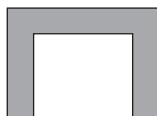

TYPE 4



TYPE 5

💡 Tips

- The photometric area stays the same even when you change the aspect ratio.

Example: TYPE 4

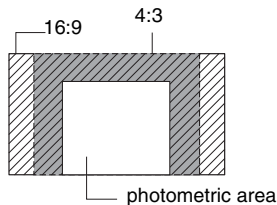

AE RESPONSE

You can select the speed at which the automatic exposure adjustment function follows changes in the brightness of the subject. You can select the speed from [FAST], [MIDDLE] and [SLOW]. The default setting is [FAST].

AT IRIS LMT

You can select the highest iris value for the automatic adjustment from [F1.1], [F9.6], [F8], [F6.8], [F5.6], [F4.8] and [F4]. The default setting is [F1.1].

Notes

- This function is not effective during the manual iris adjustment.

ECS FREQ.

You can set the shutter speed so that horizontal strips do not appear on a monitor screen, which is likely to occur when you record a monitor screen. Change the setting with the SEL/PUSH EXEC dial, then press the dial to confirm the setting. The default setting is [50.00Hz].

You must set the shutter speed to the ECS (ECS) prior to setting this function (p. 31). You can set the shutter speed in the following frequency ranges depending on the setting of [SCAN TYPE]. How to select [SCAN TYPE] depends on the setting of [REC FORMAT] of \leftarrow (IN/OUT REC) menu.

[HDV1080i]: [HDV PROGRE.] \rightarrow [REC TYPE] \rightarrow [SCAN TYPE]
[DV]: [DV PROGRE.] \rightarrow [SCAN TYPE]

SCAN TYPE	Frequency range
50	50.00 Hz to 200.0 Hz
25	25.00 Hz to 200.0 Hz

FLCKR REDUCE

ON

Reduces flickering. Flickering of the screen under a light source such as fluorescent lamps will be reduced.

OFF

Not reduce flickering. Select this when you do not want to reduce flickering.

Notes

- Flickering may not be reduced for certain light sources.

CNTRST ENHCR

When you set this function to [ON], your camcorder detects high contrast images, such as backlit scenes, and automatically improves the unexposed images. The default setting is [OFF].

Notes

- When you set [BACK LIGHT] to [ON], [CNTRST ENHCR] is temporarily disabled.

BACK LIGHT (AS)

When you set this function to [ON] (AS), you can correct backlighting. The default setting is [OFF].

Notes

- The back light function is canceled when you set [SPOTLIGHT] to [ON].

SPOTLIGHT (AS)

When you set this function to [ON] (AS), you can prevent overexposure of light

Press the MENU button → select the  (CAMERA SET) with the SEL/PUSH EXEC dial.

during recording of a subject under strong light, such as a stage. For example, you can prevent people's faces from over-highlighting. The default setting is [OFF].

Notes

- The spotlight function is canceled when you set [BACK LIGHT] to [ON].
- You cannot use the spotlight function if at least two of iris, gain, and shutter speed are adjusted manually.

STEADYSHOT

■ ON/OFF

When you select [ON], you can reduce camera shakes. Select [OFF] () when you use a tripod (optional) to make images look natural. The default setting is [ON].

■ TYPE

You can select a type of camera-shake reduction for different recording situations.

HARD

Reduces camera shakes at a high level. This setting is not suitable for panorama tilt recordings.

▶ STANDARD

Reduces camera shakes at a standard level.

SOFT

Reduces camera shakes at a low level. Slight unsteadiness remains in movies, which make the movies look as they are.

AF ASSIST

When you set this function to [ON], you can temporarily focus manually using the focus ring during the auto focus adjustment. The default setting is [OFF].

Notes

- This function is effective only when the focus ring is set to the mode B position (p. 28).

FOCUS MACRO

When you set this function to [ON], you can focus on a subject within 80 cm (about 2 5/8 feet). The default setting is [ON]. When you set this function to [OFF] () , you can set fine focus on a subject further than 80 cm regardless of the zoom position although you will lose focus on a subject within 80 cm.

Notes

- This function is effective only when the focus ring is set to the mode B position (p. 28).

HANDLE ZOOM

You can select the zoom speed for the FIX position of the handle zoom switch from [1] (slow) through [8] (fast). The default setting is [3].

D. EXTENDER

When you set this function to [ON] () , the displayed image becomes 1.5 times larger. The image quality decreases because the image is digitally processed. This function helps you to focus on far-away subjects such as a wild bird away at a distance. The default setting is [OFF].

Notes

- This function is automatically set to [OFF] when you turn the power off and back on.

FADER

You can add visual effects to transition between scenes.

- ① Select [WHITE FADER] or [BLACK FADER] during standby to fade in with the selected effect or recording to fade out with the selected effect.
- ② Press the REC START/STOP button. The fader indicator stops flashing and disappears when the fading is complete.

To cancel before starting the operation, select [OFF] in step ①. The setting will be cleared every time you press the REC START/STOP button.



WHITE FADER



BLACK FADER



Notes

- This function is automatically set to [OFF] when you turn the power off and back on.

SMTH SLW REC

Fast moving subjects and actions, which cannot be captured under the general recording conditions, can be recorded in smooth moving slow-motion. This is useful for recording fast actions such as a golf or tennis swing.

① Set [REC TIME].

Select the recording time from [3sec] (the default setting), [6sec] and [12sec]. The picture quality deteriorates as the recording time increases.

② Set [REC TIMING].

Select the recording timing from [START TRIGGR] and [END TRIGGER] to record the action after or before the REC START/STOP button is pressed.

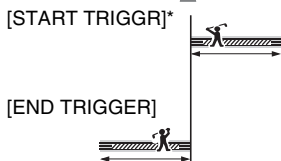

* The default setting is [START TRIGGR].

③ Start recording.

Select [EXECUTE], then press the REC START/STOP button on the [SMTH SLW REC] screen.

A slow-motion movie about 4 times longer than your [REC TIME] setting is recorded. Recording ends when [Recording...] disappears from the screen.

To cancel [SMTH SLW REC], press the MENU button.

Notes

- Sounds cannot be recorded.
- The settings are automatically cleared when you turn the power off and back on.
- The shutter speed is automatically set to 1/215 second when you start [SMTH SLW REC].
- The recording time may be shorter than the set time, depending on recording conditions.
- The image quality is lower than with the regular recording.

INTERVAL REC

You can record a series of movies on a tape at regular intervals. This function is useful to observe things like cloud movements or daylight changes. The scenes run smoothly into each other when you play back the tape. Use the AC Adapter/Charger to obtain AC power for long recording.

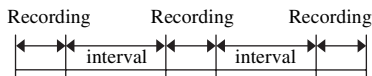

Press the MENU button → select the  (CAMERA SET) with the SEL/PUSH EXEC dial.

- ① Select [ON/OFF] → [ON] with the SEL/PUSH EXEC dial.
- ② Perform the following step if you are changing the recording time from the default setting of [0.5sec]. If you are keeping the default recording time, go straight to step ③.
Select [REC TIME] → [0.5sec], [1sec], [1.5sec] or [2sec] with the SEL/PUSH EXEC dial.
- ③ Perform the following step if you are changing the interval time from the default setting of [30sec]. If you are keeping the default interval time, go straight to step ④.
Select [INTERVAL] → [30sec], [1min], [5min] or [10min].
- ④ Select [OK] with the SEL/PUSH EXEC dial.
- ⑤ Press the MENU button to hide the menu screen.
- ⑥ Press the REC START/STOP button.
The [INTERVAL REC] recording starts.

To cancel [INTERVAL REC], press the REC START/STOP button.

The operation of your camcorder differs depending on when you press the REC START/STOP button.

If you press the button during [INTERVAL REC] recording, the recording temporarily stops. If you press it again, the [INTERVAL REC] recording restarts. If you press the button during [INTERVAL REC] interval, the [INTERVAL REC] recording stops and regular recording starts. If you press it again, regular recording stops. If you press the button once again, the [INTERVAL REC] recording restarts. To cancel the [INTERVAL REC] recording, select [ON/OFF] → [OFF] with the SEL/PUSH EXEC dial.

Notes

- The recording time and interval time may differ slightly from the settings.
- If you focus manually, you can get sharp images even if the lighting changes.

DV FRAME REC

You can record stop motion (or frame-by-frame) animation movies. That type of animation uses a technique of changing the subject, such as a doll or a toy's positions and recording it at each different position while your camcorder sits still. Use the Remote Commander to reduce camera shakes.

▶ OFF

Not use this function.

ON

Records a movie by stop motion (or frame-by-frame) technique.

- ① Select [ON] with the SEL/PUSH EXEC dial.
- ② Press the MENU button to hide the menu screen.
- ③ Press the REC START/STOP button.
Your camcorder records a movie for about 5 frames and returns to standby.
- ④ Move the subject and repeat step ③.

Notes

- When you use frame recording continuously, the remaining tape time will not be indicated correctly.
- The last scene will be longer than other scenes.
- You cannot record index signals during frame recording.
- This function is automatically set to [OFF] when you turn the power off and back on.

SHOT TRANSITION

See page 46.

S. TRANS/F. MARK

You can select a function to be assigned to the SHOT TRANSITION/FOCUS MARKING button.

► SHOT TRANSITION

Select to assign the shot transition function to the button.

FOCUS MARKING

Select to assign the focus marking function to the button.

x.v.Color HDV1080i

When you set this function to [ON], you can record with the wider color range. Your camcorder can reproduce brilliant and vivid colors for flowers and the beautiful blue-green of tropical oceans that cannot be matched by conventional technologies.

🔊 Notes

- The colors may not be well reproduced when you play back a movie recorded with this function set to [ON] on a TV that does not support x.v.Color.
- You cannot set [x.v.Color] in the following cases:
 - When recording in SD (standard) format
 - When recording movies
- When you set [x.v.Color] to [ON], the picture profile will be disabled.

COLOR BAR AS

■ ON/OFF

When you select [ON], you can display color bars on the screen or record them on a tape. This function helps you to adjust colors when you view movies recorded with your camcorder on a TV or a monitor. The default setting is [OFF].

🔊 Notes

- This function is automatically set to [OFF] when you turn the power off and back on.

■ TYPE

Selects a type of the color bars.



TYPE 1



TYPE 2



TYPE 3



TYPE 4 (75% brightness of TYPE 3)

■ TONE

Outputs audio tone signals (1 kHz: full bit -20 dB) when you set [TONE] to [ON]. The default setting is [OFF].

Press the MENU button → select the  (CAMERA SET) with the SEL/PUSH EXEC dial.

FLANGE BACK

You can select a mode for the flange focal length adjustment. The flange focal length is a distance from the lens flange to the plane of the image along the optical axis. See page 10 for details.

▶ AUTO ADJUST

Automatically adjusts the flange focal length.

MANU ADJUST

Manually adjusts the flange focal length.

(AUDIO SET) menu

Settings for the audio recording (DV AU.MODE/XLR SET, etc.)

The default settings are marked with ▶. The indicators in parentheses appear when the items are selected.

See page 64 for details on selecting menu items.

Press the MENU button → select the  (AUDIO SET) with the SEL/PUSH EXEC dial.

DV AU.MODE (DV Audio mode)

FS32K (32k)

Records in the 12-bit mode (2 stereo sounds). Select this setting for the DVCAM/DV SP recording.

▶ FS48K (48k)

Records in the 16-bit mode (1 stereo sound with high quality). Select this setting for the DVCAM/DV SP recording.

Notes

- When recording in the HDV format, sound is automatically recorded in the [FS48K] mode.

AUDIO LIMIT

You can set the clipping-noise reduction function for CH1/CH2.

▶ OFF

Disables the function.

ON

Enables the function.

Notes

- This function is available only when you set the AUTO/MAN switch to MAN.

XLR SET

■ XLR AGC LINK

You can select either linked or separate AGC (Auto Gain Control) of CH1 and CH2 when using an external microphone.

► SEPARATE

Separately applies the AGC for CH1/CH2. Sound inputs from CH1/CH2 will be recorded as separate sound.

LINKED

Applies the AGC of CH1 linked with that of CH2. Sound inputs from CH1/CH2 will be recorded as a set of sound such as stereo sound. A  appears on the status check screen.

⚙ Notes

- This function is available when the CH1 and CH2 switches are set to AUTO and the INPUT1 and INPUT2 switches are both set to MIC or both set to LINE (p. 41).

■ AU.MAN GAIN

You can select either linked or separate audio level control of CH1 and CH2 when using an external microphone.

► SEPARATE

Separately controls the audio levels of CH1 and CH2. Sound inputs from CH1 and CH2 will be recorded as separate sound.

LINKED

Controls the audio level of CH1 linked with that of CH2. Sound inputs from CH1 and CH2 will be recorded as a set of sound such as stereo sound. M  appears on the status check screen.

⚙ Notes

- This function is available when the CH1 and CH2 switches are set to MAN and the INPUT1 and INPUT2 switches are both set to MIC or both set to LINE (p. 41).
- When you select [LINKED], you can adjust the volume with the AUDIO LEVEL dial of CH1 (p. 41).

■ INPUT1 MIC NR

Reduces noise from the microphone.

► ON

Reduces noise from the microphone.

NR appears on the status check screen.

OFF

Does not reduce noise from the microphone.

⚙ Notes

- The setting is not effective when you set the INPUT1 switch to LINE.

■ INPUT1 TRIM

Adjusts the input signal level from INPUT1.

You can select from [-18dB], [-12dB], [-6dB], [0dB], [6dB] and [12dB]. The default setting is [0dB].

⚙ Notes

- The setting is not effective when you set the INPUT1 switch to LINE.

■ INPUT1 WIND

► OFF

Disables wind noise reduction.

ON

Enables wind noise reduction.

 appears on the status check screen.

⚙ Notes

- The setting is not effective when you set the INPUT1 switch to LINE.

■ INPUT2 MIC NR

■ INPUT2 TRIM

■ INPUT2 WIND

You can set INPUT2 in the same way as INPUT1.

💡 Tips

- 48 dBu is set as 0dB in your camcorder.
- Set [INPUT TRIM] to [0dB] for the supplied microphone (ECM-XM1).
- Set [INPUT TRIM] to [12dB] for the optional microphone (Sony ECM-NV1).
- The INPUT TRIM function adjusts the input level from an external microphone. When using a highly sensitive microphone or recording loud sound, set this to the minus side. When using a less sensitive microphone or recording quiet sound, set it to the plus side.

Press the MENU button → select the  (AUDIO SET) with the SEL/PUSH EXEC dial.

- When recording loud sound, the sound may be distorted at either the input point or the recording point. If it is distorted at the input point, adjust the sound using the INPUT TRIM function. If it is distorted at the recording point, lower the total volume level manually.
- If you set INPUT TRIM too far to the minus side, the microphone volume becomes too low, resulting in a poor signal to noise ratio.
- Test the effect of the INPUT TRIM function according to the microphone used or the sound field of the recording site before actual recording.

CH3,CH4

Outputs only the sound dubbed in CH3 and CH4.

AUDIO CH SEL

▶ CH1,CH2

Reproduces sound of CH1 and CH2 in respective channels.

CH1

Reproduces sound of CH1 in channels 1 and 2.

CH2

Reproduces sound of CH2 in channels 1 and 2.

Tips

- When you select [CH1,CH2] and play back a tape on your camcorder, sound of CH1 + CH2 comes out of the speakers.

DV AUDIO MIX

You can monitor the sound dubbed from another device or recorded through 4-channel microphone during playback. You can set how to output the sound.

▶ CH1,CH2

Outputs only the sound recorded in CH1 and CH2 during recording.

MIX

Outputs mixed sound of the sound recorded in CH1 and CH2 during recording and the sound dubbed in CH3 and CH4.

(DISPLAY SET)

menu

Display settings of the display and the viewfinder (MARKER/VF B.LIGHT/DISP OUTPUT, etc.)

The default settings are marked with ►. The indicators in parentheses appear when the items are selected.

See page 64 for details on selecting menu items.

Press the MENU button → select the  (DISPLAY SET) with the SEL/PUSH EXEC dial.

ZEBRA (AS)

You can display a zebra pattern as a guide for adjusting brightness.

■ ON/OFF

When you select [ON],  and the brightness level appear on the screen. The zebra pattern will not be recorded on a tape or a “Memory Stick Duo.”

■ LEVEL

You can select the brightness level between 70 and 100 or 100+.

💡 Tips

- The zebra pattern is a strip pattern displayed over a part of an image on the screen when the part is higher than a preset brightness level.

HISTOGRAM

You can adjust the iris while referring to a histogram. A histogram is a graph that shows the distribution of the image brightness. You can use the histogram as a guide for adjusting the iris. The histogram will not be recorded on a tape or a “Memory Stick Duo.”

► OFF

Does not display a histogram.

NORMAL

Displays a histogram.

ADVANCE

Displays a histogram, and a bar that indicates an average of the brightness levels around the center of an image (within the marker) on the histogram.

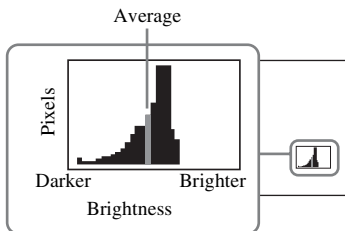

💡 Tips

- The left area on the graph shows the darker areas of the image while the right area shows the brighter areas.
- A vertical line that indicates the brightness level of [ZEBRA] will be displayed on the histogram when you set [ZEBRA] to [ON].

PEAKING (AS)

■ ON/OFF

When you select [ON], you can display an image on the screen with its details enhanced. This function helps you to adjust the focus. The default setting is [OFF].

■ LEVEL

You can select a peaking sensitivity from [HIGH], [MIDDLE] and [LOW]. The default setting is [MIDDLE].

💡 Notes

- You cannot record an image with enhanced details on a tape or a “Memory Stick Duo.”

Press the MENU button → select the  (DISPLAY SET) with the SEL/PUSH EXEC dial.

Tips

- You can focus more easily using this function in combination with the expanded focus function (p. 29).

MARKER AS

■ ON/OFF

When you select [ON], you can display markers. The default setting is [OFF]. Markers will not be recorded on a tape or “Memory Stick Duo.”

■ CENTER

When you select [ON], you can display a marker at the center of the screen. The default setting is [ON].



■ ASPECT

When you select [ON], you can display markers at boundaries of display area defined by the aspect ratio, which you can select from [4:3], [13:9] and [14:9]. The default setting is [OFF].



■ SAFETY ZONE

When you select [ON], then [80%] or [90%], you can display markers at boundaries of display area that regular home TVs can display. The default setting is [OFF].



■ GUIDEFRAME

When you select [ON], you can display frame markers that help you to check horizontal and vertical positions of a subject. The default setting is [OFF].



Notes

- You cannot display markers on an external device connected to your camcorder via an analog jack.
- You cannot display markers when you set [DATE REC] to [ON].

Tips

- You can display all types of markers at the same time.
- You can obtain a balanced composition by positioning the subject at the cross points of the guideframe marker.
- You can display markers only on the LCD panel and viewfinder. You cannot display them on an external device.

CAM LEVELING

When you set this function to [ON], you can display a level meter to check the level of your camcorder. The default setting is [OFF].

EXP.FOCUS TYPE

You can set a type of the expanded focus display.

▶ TYPE 1

Simply enlarges images.

TYPE 2

Enlarges and shows images in white and black.

CAM DATA DSP (Camera data display)

When you set this function to [ON], you can constantly display the iris, shutter speed and gain settings on the screen. The default setting is [OFF].

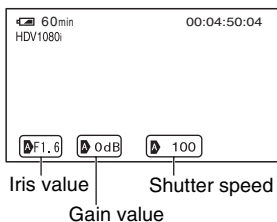

Tips

- The settings appear on the screen during the manual adjustment regardless of the settings of this function.
-  indicates that the settings are automatically adjusted values.
- The displayed settings are different from the settings that will be displayed when you press the DATA CODE button (p. 53).

AU.LVL DISP (Audio level display)

When you set this function to [ON], you can display the audio level meter on the screen. The default setting is [ON].

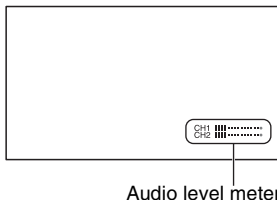

Audio level meter

ZOOM DISPLAY

► BAR

Displays a bar that indicates the zoom position.

NUMBER

Displays a number (0 through 99) that indicates the zoom position.

FOCUS DISP

You can select how to display the focal distance during manual focus.

► METER

Displays the focal distance in meters.

FEET

Displays the focal distance in feet.

SHUTTER DISP

You can select how to display the shutter speed.

► SECOND

Displays the shutter speed in seconds.

DEGREE

Displays the shutter speed in degrees.

The shutter speed equal to the period that your camcorder reads image data from the image sensor is defined as 360 degrees.

The degree is calculated based on this definition and displayed.

– When [SCAN TYPE] is set to [50], 1/50 second is defined as 360 degrees.

– When [SCAN TYPE] is set to [25], 1/25 second is defined as 360 degrees.

For details on [SCAN TYPE], see [HDV PROGRE.] (p. 84) or [DV PROGRE.] (p. 84).

🔊 Notes

- When you press the DATA CODE button, the shutter speed will be displayed in seconds regardless of the setting of this function.

Press the MENU button → select the  (DISPLAY SET) with the SEL/PUSH EXEC dial.

Tips

- Shutter speed slower than 360° are displayed in multiples of 360°, such as 360° × 2.

LCD BRIGHT

You can adjust the brightness of the LCD screen. Changes in the LCD brightness will not affect the brightness of recording images.

Tips

- You can also turn off the LCD backlight (p. 18).

LCD COLOR

You can adjust the color level of the LCD panel. Changes in the LCD color level will not affect the color level of recording images.

LCD BL LEVEL

You can adjust the backlight level of the LCD screen.

▶ NORMAL

Standard brightness.

BRIGHT

Brightens the LCD screen.

Notes

- When you connect your camcorder to outside power sources, [LCD BL LEVEL] is automatically set to [BRIGHT].
- When you select [BRIGHT], the recordable time with the battery is slightly reduced.

VF B. LIGHT

You can adjust the brightness of the viewfinder.

▶ NORMAL

Standard brightness.

BRIGHT

Brightens the viewfinder screen.

Notes

- When you connect your camcorder to outside power sources, [BRIGHT] is automatically selected for the setting.
- When you select [BRIGHT], the recordable time with the battery is slightly reduced.

VF COLOR

▶ ON

Displays images in the viewfinder in color.

OFF

Displays images in the viewfinder in black and white.

VF POWERMODE

▶ AUTO

Turns on the viewfinder while you close the LCD panel or record in mirror mode.

ON

Always turns on the viewfinder.

LETTER SIZE

▶ NORMAL

Displays the menu in regular letter size.

2x

Displays the selected menu items in letter size, the height of which is doubled.

REMAINING

▶ AUTO

Displays the remaining time of a tape for about 8 seconds in the following situation:

- When you set the POWER switch to VCR or CAMERA with a cassette inserted.
- When you press  (Play) or the DISPLAY/BATT INFO button.

ON

Always displays the remaining time of a tape. The remaining time is not displayed when you insert a new tape or a tape that is

rewound to the beginning. It is displayed when you start playback or recording.

DISP OUTPUT

You can select outputs to which display information, such as time code, is outputted.

► LCD PANEL

Outputs the information to the LCD screen and viewfinder.

V-OUT/PANEL

Outputs the information to the LCD screen and composite output.

ALL OUTPUT

Outputs the information to the LCD screen, HDMI output, component output and composite output.

⇄ (IN/OUT REC) menu

Recording settings, input and output settings (REC FORMAT/HDV PROGRE./VIDEO OUT/EXT REC CTRL, etc.)

The default settings are marked with ►. The indicators in parentheses appear when the items are selected.

See page 64 for details on selecting menu items.

Press the MENU button → select the ⇄ (IN/OUT REC) with the SEL/PUSH EXEC dial.

REC FORMAT

You can select a recording format.

► HDV1080i (HDV1080i)

Records in the HDV1080i format.

DV (DVCAM DV SE)

Records in the DVCAM (DV) format. Set also [DV REC MODE] when you record in this format.

⚙ Notes

- Set also [i.LINK SET] when you output a movie to an external device through an i.LINK cable (p. 86).

VCR HDV/DV

You can select a type of output signal to an external device for playing back a movie on the device. Select [AUTO] in most cases. When you connect your camcorder to an external device with an i.LINK cable, select a type of input and output signals to and from the external device via the i.LINK HDV/DV jack. You can record or play back a movie reproduced by the selected type of signals.

► AUTO

Automatically switches between HDV signals and DV signals during playback.

During the i.LINK connection, recognizes HDV signals and DVCAM (DV) signals, and automatically inputs or outputs the

Press the MENU button → select the  (IN/OUT REC) with the SEL/PUSH EXEC dial.

signals to or from the external device via the  HDV/DV (i.LINK) jack for recording or playback.

HDV (HDV1080i)

Plays back only HDV format sections of a tape.

During the i.LINK connection, inputs or outputs only HDV signals to or from an external device via the  HDV/DV (i.LINK) jack for recording or playback. Select this setting when you connect your camcorder to your computer.

DV (DV)

Plays back only DVCAM (DV) format sections of a tape.

During the i.LINK connection, inputs or outputs only DVCAM (DV) signals to or from an external device via the  HDV/DV (i.LINK) jack for recording or playback. Select this setting when you connect your camcorder to your computer.

Notes

- Make sure to disconnect the i.LINK cable prior to changing the setting. Otherwise, a video device may not recognize video signals.
- When you select [AUTO], images and sounds may be cut off on switching between HDV signals and DVCAM (DV) signals.
- When you set [i.LINK SET] → [HDV → DV CONV] to [ON], the following signals will be outputted:
 - [AUTO]: HDV signals are converted to DVCAM (DV) signals and outputted. DVCAM (DV) signals are outputted without any conversion.
 - [HDV]: HDV signals are converted to DVCAM (DV) signals and outputted. DVCAM (DV) signals will not be outputted.
 - [DV]: DVCAM (DV) signals are outputted without any conversion. HDV signals will not be outputted.

HDV PROGRE.

■ REC TYPE

You can select an HDV recording format from [INTERLACE] and [PROGRESSIVE].

■ SCAN TYPE

You can select a scan type for recording in HDV format.

▶ 50

Records by the interlace scan.

25

Records 25 frames per second.

Notes

- Selectable [SCAN TYPE] settings differ depending on the setting of [REC TYPE].
 - [INTERLACE]: [50], [25]
 - [PROGRESSIVE]: [25]
- You can only play back a tape recorded with the [REC TYPE] set to [PROGRESSIVE] on a device that supports playback of a tape recorded by progressive scanning.

DV PROGRE.

■ SCAN TYPE

You can select a scan type for recording in DVCAM/DV format.

▶ 50

Records by the interlace scan.

25

Records 25 frames per second.

DV REC MODE (DV Recording mode)

This function is available only when you set [REC FORMAT] to [DV].

▶ DVCAM (DVCAM)

Records in the DVCAM format.

DV SP (DV

Records in the SP (Standard Play) mode of the DV format to record for a longer time than in the DVCAM format.

Notes

- Mosaic-like disturbance or audio interruption may occur when you play back a movie recorded in the DV SP mode by another device.

- Image may be distorted or time code may not be properly connected between the scenes recorded in the DVCAM mode and DV SP mode.

DV WIDE REC

DVCAM DV SP

You can record a movie in an aspect ratio that matches that of a TV that you want to connect. Refer also to the instruction manuals that come with the TV.

► ON

Records a movie in an aspect ratio that matches the full screen of a 16:9 (wide) TV.

OFF (4:3)

Records a movie in an aspect ratio that matches the full screen of a 4:3 TV.

🔊 Notes

- Set [DV WIDE CONV] correctly to suite a TV that you want to connect for playback (p. 84).
- The aspect ratio will be fixed to 16:9 and you cannot set it to 4:3 when you record in HDV format.

VIDEO OUT

■ COMPONENT

You can select [576i] or [1080i/576i] depending on your TV when you connect your camcorder to a TV via a component cable.

576i

Supports connection between your camcorder and a TV with a component input jack that supports the 576i format.

► 1080i/576i

Supports connection between your camcorder and a TV with a component input jack that supports the 1080i format.

■ DOWN CONVERT

You can select a down convert type when you down-convert HDV signal to DV signal. Use this function for signals outputting from the following output jacks:

- Component (576i)

- S Video
- Audio/Video

► SQUEEZE

Outputs a horizontally compressed image while maintaining its original height.

LETTER BOX

Outputs an image with black bars added to the top and bottom of the original image, while maintaining the original aspect ratio.

EDGE CROP

Outputs the central portion of the original image by cropping its right and left edges.

🔊 Notes

- When you view a movie recorded in the DVCAM (DV) format with [DV WIDE REC] set to [ON] on a standard 4:3 TV, images of the movie may appear vertically compressed. In such a case, set [DV WIDE CONV] to [LETTER BOX] or [EDGE CROP].

■ DV WIDE CONV

You can select a down convert type when you down-convert DV widescreen signal to DV signal.

Use this function for signals outputting from the following output jacks:

- Component (576i)
- S Video
- Audio/Video

► SQUEEZE

Outputs a horizontally compressed image while maintaining its original height.

LETTER BOX

Outputs an image with black bars added to the top and bottom of the original image, while maintaining the original aspect ratio.

EDGE CROP

Outputs the central portion of the original image by cropping its right and left edges.

Press the MENU button → select the  (IN/OUT REC) with the SEL/PUSH EXEC dial.

i.LINK SET

■ HDV → DV CONV

When you set this function to [ON], you can convert HDV format signals to DV format signals and output the DV format signals to an external device via the  HDV/DV (i.LINK) jack. You can output DV format signals without any format conversion. The default setting is [OFF].

■ DOWN CONVERT

You can set a down convert type when you set [HDV → DV CONV] to [ON] to convert HDV format signals to DV format signals.

▶ SQUEEZE

Outputs a horizontally compressed image while maintaining its original height.

EDGE CROP

Outputs the central portion of the original image by cropping its right and left edges.

⚙ Notes

- For i.LINK connection, see [VCR HDV/DV] (p. 83).
- Disconnect the i.LINK cable before setting [i.LINK SET]. Otherwise, the connected video device may not be able to recognize the video signal from your camcorder.

EXT REC CTRL

You can connect your camcorder to an HDV/DVCAM/DV compatible device (digital HD video camera recorder, digital video camera recorder, hard disc recorder, etc.) with an i.LINK cable, and record movies on your camcorder and the connected device simultaneously, or continue recording from your camcorder to the connected device.

Refer also to the instruction manuals supplied with the connecting devices.

■ REC CTL MODE

▶ OFF

Does not record on a connected device.

SYNCHRONOUS (EXT)

Records movies, sound and time code on a connected device in synchronization with your camcorder.

RELAY (EXT)



Records movies, sound and time code on a connected device when a tape on your camcorder reaches close to the end during recording.

EXT ONLY (EXT)

You can operate an external recording unit* with the REC START/STOP button of your camcorder.

*HVR-MRC1 (supplied) or HVR-DR60 (optional)

⚙ Notes

- When this function is set to [EXT ONLY],  does not flash even when there is no tape inserted.
- You can use the REC START/STOP button of your camcorder as a recording start/stop button for the external recording unit when you set this function to [EXT ONLY]. Use the REC button of the video control buttons (p. 135) to start recording on a tape or the STOP button to stop recording.
- **EXT ** (EXT ONLY) flashes when you connect an external recording unit that is not supported by [EXT ONLY].

■ STBY COMMAND

▶ REC PAUSE

Stops recording operation of a connected device by putting it in pause when you stop recording operation of your camcorder.

STOP

Stops recording operation of a connected device when you stop recording operation of your camcorder.

00:00 (TC/UB SET) menu

(TC PRESET/UB PRESET/TC LINK, etc.)

The default settings are marked with ►.
The indicators in parentheses appear when the items are selected.

See page 64 for details on selecting menu items.

Press the MENU button → select the 00:00 (TC/UB SET) with the SEL/PUSH EXEC dial.

TC PRESET

■ PRESET

You can preset the time code.

- ① Select [TC PRESET] with the SEL/PUSH EXEC dial.
- ② Select [PRESET] with the SEL/PUSH EXEC dial.
- ③ Select the first 2 digits with the SEL/PUSH EXEC dial.
You can set the time code between 00:00:00:00 and 23:59:59:24.
- ④ Set other digits by repeating step ③.
- ⑤ Select [OK] with the SEL/PUSH EXEC dial.

■ RESET

You can reset the time code (00:00:00:00). Select [RESET] in step ① of the [PRESET].

TC COUNTUP (AS)

You can increment the hour of time code by 1 and reset the minute, second and frame of time code when you execute this function.

🔊 Notes

- This function is available only when you set [TC MAKE] to [PRESET].

UB PRESET

■ PRESET

You can preset the user bit.

- ① Select [UB PRESET] with the SEL/PUSH EXEC dial.

- ② Select [PRESET] with the SEL/PUSH EXEC dial.
- ③ Select the first 2 digits with the SEL/PUSH EXEC dial.
- ④ Set other digits by repeating step ③.
- ⑤ Select [OK] with the SEL/PUSH EXEC dial.

■ RESET

You can reset the user bit (00 00 00 00). Select [RESET] in step ① of the [PRESET].

TC RUN

You can select how the time code advances.

► REC RUN

Advances the time code only during recording.

Select this setting to record the time code continuous from the last time code of the previous recording.

FREE RUN

Advances the time code regardless of operation of your camcorder.

Select this setting to save the actual time in the time code.

TC MAKE

► REGENERATE

Reads the last time code of the previous recording from the tape and records the new time code consecutively from the last time code during the backspace editing. The time code runs in [REC RUN] mode regardless of the setting of [TC RUN].

PRESET

Records the newly set time code on the tape.

TC LINK

You can synchronize the time codes of multiple camcorders. This function is useful for editing movies recorded by multiple camcorders.

Press the MENU button → select the **00:00** (TC/UB SET) with the SEL/PUSH EXEC dial.

- ① Insert a tape to the main camcorder from which you want to generate the time code.
- ② Set the POWER switches of the main and sub camcorders to CAMERA.
- ③ Connect the sub camcorder to the main camcorder with an i.LINK cable.
- ④ Set the main and sub camcorder as follows:
 - Set [TC RUN] to [FREE RUN] (p. 87).
 - Set [TC MAKE] to [PRESET] (p. 87).

Set the sub camcorders as follows:

- ⑤ Select [TC/UB SET] → [TC LINK] with the SEL/PUSH EXEC dial.
The message [Synchronize TC with connected device?] appears.
- ⑥ Select [YES] to synchronize the time code of the sub camcorder with that of the main camcorder. Disconnect the i.LINK cable from your camcorders when synchronization is completed. You can record with the synchronized time codes using those camcorders.

🔊 Notes

- If you want to execute [TC LINK] for more than two camcorders, repeat the steps for multiple sub camcorders with one main camcorder.
- Some frame shifting may occur over time after time code synchronization.
- Some frame shifting may occur if you turn the power off and back on. In such a case, set [TC LINK] again.

UB TIME REC

▶ OFF

Does not save the actual time in the user bit code.

ON

Saves the actual time in the user bit code.

UB-DATE/TC-TIME

You can save the date and time set in your camcorder in the user bit and time code, respectively, when you do this function.

🔊 Notes

- This function is available in the following cases:
 - [TC MAKE] : [PRESET]
 - [TC RUN] : [FREE RUN]
 - [UB TIME REC] : [OFF]
- The time lag may occur between the set time code and the actual time as time goes on. Do [UB-DATE/TC-TIME] again prior to recording.
- The date saved in the user bit will not be automatically updated even when the actual date has been changed.

(MEMORY SET) menu

Settings for the “Memory Stick Duo” (ALL ERASE/FORMAT, etc.)

The default settings are marked with ►.
The indicators in parentheses appear when the items are selected.

See page 64 for details on selecting menu items.

Press the MENU button → select the  (MEMORY SET) with the SEL/PUSH EXEC dial.

ALL ERASE

You can delete all the still images without image protection on a “Memory Stick Duo” or in the selected folder.

- ① Select [ALL FILES] or [CURRENT FLDR].
[ALL FILES]: Deletes all the images on the “Memory Stick Duo.”
[CURRENT FLDR]: Deletes all the images in the currently selected folder.
- ② Select [YES] → [YES] with the SEL/PUSH EXEC dial.
[ Erasing all data...] appears.
[Completed.] appears when all unprotected images are deleted.

Notes

- Release the write protect tab on the “Memory Stick Duo” beforehand for the “Memory Stick Duo” with the write-protect tab (p. 119).
- The folder will not be deleted even when you delete all the images in the folder.
- Do not do any of the following while [ Erasing all data...] is displayed:
 - Operate the POWER switch/buttons.
 - Eject the “Memory Stick Duo.”

FORMAT

You do not need to format the “Memory Stick Duo” since it is already formatted at the factory. If you want to format the “Memory Stick Duo,” select [YES]→[YES].

Notes

- Do not do any of the following while [ Formatting...] is displayed:
 - Operate the POWER switch/buttons.
 - Eject the “Memory Stick Duo.”
- Formatting erases everything on the “Memory Stick Duo” including protected image data and newly created folders.

FILE NO.

► SERIES

Assigns file numbers in sequence even if the “Memory Stick Duo” is replaced with another one. The file number is reset when a new folder is created or the recording folder is replaced with another.

RESET

Resets the file number to 0001 each time the “Memory Stick Duo” is changed.

NEW FOLDER

When you select [YES], you can create a new folder (102MSDCF to 999MSDCF) on a “Memory Stick Duo.” When a folder is full (a maximum of 9,999 images are stored), a new folder is automatically created.

Notes

- You cannot delete the new folder once you have created it on your camcorder. Format the “Memory Stick Duo” (p. 89) or delete it on your computer.
- The number of recordable pictures on a “Memory Stick Duo” may decrease as the number of folders increases.

Press the MENU button → select the  (MEMORY SET) with the SEL/PUSH EXEC dial.

REC FOLDER (Recording folder)

You can select a folder in which you want to store still images.

Select the folder with the SEL/PUSH EXEC dial.

Tips

- The still images will be stored in the 101MSDCF folder by default.
- Once you store the still images in the current folder, the folder is selected as a playback folder.

PB FOLDER (Playback folder)

You can select a folder in which still images you want to view are stored.

Select the folder with the SEL/PUSH EXEC dial.

(OTHERS) menu

Settings while recording on a tape or other basic settings (QUICK REC/BEEP, etc.)

The default settings are marked with ►.

The indicators in parentheses appear when the items are selected.

See page 64 for details on selecting menu items.

Press the MENU button → select the  (OTHERS) with the SEL/PUSH EXEC dial.

CAMERA PROF. (Camera profile)

You can save up to 99 camera setting profiles on a “Memory Stick Duo” and two profiles in your camcorder. Using these saved profiles let you quickly obtain suitable camera settings later. When using multiple camcorders of this model, you can save the setting on a “Memory Stick Duo” and load them into the other camcorders.

Tips

- You can save menu settings, picture profiles and button settings as a camera profile.

■ To load a camera profile

You can load a camera profile and use it on your camcorder.

- ① Select [LOAD] with SEL/PUSH EXEC dial.
- ② Select the camera profile that you want to load with the SEL/PUSH EXEC dial.
- ③ Select [YES] in the check screen. Your camcorder is restarted and the selected camera profile becomes effective.

Notes

- You cannot load camera profile that has been saved by a different model of camcorder or edited on a computer.

■ To save a camera profile

- ① Select [SAVE] with the SEL/PUSH EXEC dial.
- ② Select [MEMORY STICK] with the SEL/PUSH EXEC dial to save the camera profile on the “Memory Stick

Duo” or [CAMERA] to save it in your camcorder.

- ③ Select [NEW FILE] or an existing profile name with the SEL/PUSH EXEC dial.
- ④ Select [YES] in the check screen with the SEL/PUSH EXEC dial.
The camera profile is saved.

Tips

- When you select [NEW FILE] in [MEMORY STICK], a camera profile is saved as [MS01] the first time you save a camera profile.
- When you select [NEW FILE] in [CAMERA], a camera profile is saved as [CAM1] or [CAM2].
- When you select an existing camera profile, the new camera profile is overwritten.
- You cannot view nor edit a camera profile saved on a “Memory Stick Duo” on your computer.
- You can save a camera profile on a “Memory Stick Duo” that has still image data.

■ To change the camera profile name

You can change the camera profile name.

- ① Select [PROFILE NAME] with the SEL/PUSH EXEC dial.
- ② Select the camera profile of which you want to change the name with the SEL/PUSH EXEC dial.
[PROFILE NAME] screen appears.
- ③ Change the profile name with the SEL/PUSH EXEC dial.

Tips

- You can enter the name in the same way as the picture profile (p. 41).
- ④ Select [OK] with the SEL/PUSH EXEC dial.
Profile name is changed.

■ To delete camera profile settings

- ① Select [DELETE] with the SEL/PUSH EXEC dial.
- ② Select the camera profile you want to delete with the SEL/PUSH EXEC dial.
- ③ Select [YES] on the check screen.

■ To copy a camera profile

You can copy camera profile saved on your camcorder to a “Memory Stick Duo.”

- ① Select [COPY] with the SEL/PUSH EXEC dial.
- ② Select the camera profile that you want to copy with the SEL/PUSH EXEC dial.
- ③ Select [MEMORY STICK] or [CAMERA] for a “Memory Stick Duo” or your camcorder as a copy destination of the camera profile.
- ④ Select [NEW FILE] or an existing profile name with the SEL/PUSH EXEC dial.
- ⑤ Select [YES] on the check screen.

Tips

- You can copy a camera profile saved on a “Memory Stick Duo” to your camcorder.

ASSIGN BTN

See page 43.

CLOCK SET

See page 20.

WORLD TIME

When you use your camcorder abroad, you can adjust the clock to the local time by setting the time difference with the SEL/PUSH EXEC dial.

When you set the time difference to 0, the clock returns to the original setting.

LANGUAGE

You can select the language to be used on the LCD screen.

Tips

- Your camcorder offers [ENG[SIMP]] (simplified English) in case that you cannot find your native tongue among the options.

Press the MENU button → select the  (OTHERS) with the SEL/PUSH EXEC dial.

PB ZOOM (Playback zoom)

When you set this function to [ON], you can enlarge movie images about 1.1 to 5 times (still images about 1.5 to 5 times) with the handle zoom lever. The default setting is [OFF]. To end the zoom, press and hold the W side of the handle zoom lever until it stops.

Tips

- To move the zoom horizontally, press the SEL/PUSH EXEC dial, then turn the dial. To move the zoom vertically, press the SEL/PUSH EXEC dial one more time, then turn the dial.

QUICK REC

You can slightly reduce the recording start point time when resuming recording by changing the POWER switch from OFF to CAMERA.

▶ OFF

It takes some time to restart recording from the state that the drum has stopped rotating, but the transition from the last recorded scene is smooth.

ON (Q.REC)

The time shortens slightly until recording restarts from the state that the drum has stopped rotating, but the transition from the last recorded scene may not be smooth. Select this when you do not want to miss a recording chance.

Tips

- When this function is set to [ON], the interval between scenes freezes for a moment (editing on your computer is recommended).
- When the camcorder is left in standby for more than about 3 minutes, your camcorder exits from standby (the drum stops rotating) to prevent tape wear and battery loss. Since the power does not turn off, you can restart recording by pressing the REC START/STOP button again.

DATE REC

▶ OFF

Does not superimpose the date and time on images.

ON

Superimposes the date and time on images.

Tips

- When {DV WIDE REC} is set to [OFF], the date and time are displayed outside the 4:3 area but properly recorded on images.
- When you record in the HDV format, the date and time are displayed at different positions during recording and playback.

BEEP

▶ OFF

Cancels the melody.

ON

Activates a melody when you start/stop recording.

REC LAMP[F] (Recording lamp [front])

When you set this function to [OFF], you can turn off the front camera recording lamp during recording. The default setting is [ON].

REC LAMP[R] (Recording lamp [rear])

When you set this function to [OFF], you can turn off the rear camera recording lamp during recording. The default setting is [ON].

REMOTE CTRL (Remote control)

When you set this function to [ON], you can use the supplied Remote Commander (p. 136). The default setting is [ON].

Tips

- Set to [OFF] to prevent your camcorder from responding to a command sent by another VCR remote control unit.

HOURS METER

You can display the cumulative operation time of your camcorder with the total hours of operation, drum rotation, tape running, or the total number of tape unthreading operations.

OPERATION

Displays the total hours of operation in 10-hour increments.

DRUM RUN

Displays the total hours of drum rotation in 10-hour increments.

TAPE RUN

Displays the total hours of tape running in 10-hour increments.

THREADING

Displays the total number of tape unthreading operation in 10-operation increments.

Dubbing to VCR, DVD/HDD device, etc.

Connect your camcorder to the wall socket using the supplied AC Adaptor for this operation (p. 14). Refer also to the instruction manuals supplied with the devices to be connected.

Connecting to external devices

The connection method and the image quality will differ depending on the VCR, DVD/HDD device and the connectors used.

Jacks on your camcorder

Open the jack cover and connect the cable.

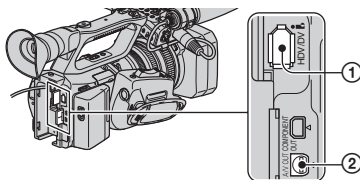

: Signal flow

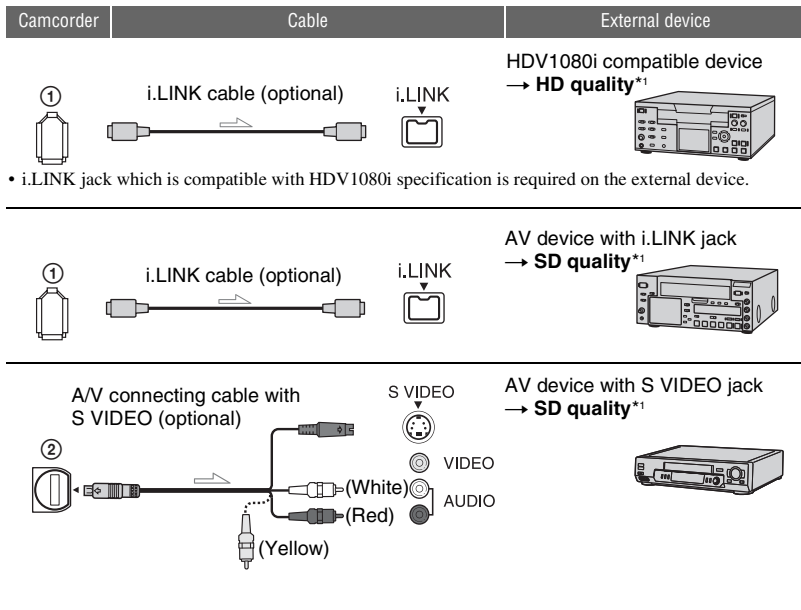

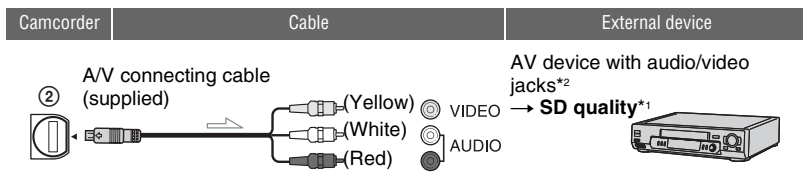

*1 Pictures recorded in the DVCAM (DV) format are dubbed in the SD (standard definition) quality, regardless of the connection.

*2 When connecting your camcorder to a monaural device, connect the yellow plug of the A/V connecting cable to the video jack on the device, and connect the white (left channel) or red (right channel) plug to the audio jack on the device.

Notes

- You cannot dub pictures using the HDMI cable.

Using an i.LINK cable (optional)

The dubbed format (HDV/DV) differs depending on the recording format or the format supported by the VCR/DVD device. See the table below for selecting the appropriate settings, and perform necessary menu setting.

Notes

- Disconnect the i.LINK cable before changing these menu settings, otherwise the VCR/DVD device may not correctly identify the video signal.

Tips

- This camcorder has a 6-pin i.LINK terminal. Select a cable that fits the terminal on the device to be connected.

Dubbing to VCR, DVD/HDD device, etc. (Continued)

Copy format	Camcorder recording format	Format supported by the VCR/DVD device		Menu setting	
		HDV format* ¹	DVCAM (DV) format	[VCR HDV/DV] (p. 83)	[i.LINK SET] (p. 86)
Copy HDV recording as HDV	HDV	HDV	—* ³		[OFF]
Convert HDV recording to DVCAM (DV)	HDV	DVCAM (DV)	DVCAM (DV)	[AUTO]	[ON]
Copy DVCAM (DV) recording as DVCAM (DV)	DVCAM (DV)	DVCAM (DV)	DVCAM (DV)		[OFF]
When tape is recorded in both HDV and DVCAM (DV) format					
Convert both HDV and DVCAM (DV) format to DVCAM (DV)	HDV/DVCAM (DV)	DVCAM (DV)	DVCAM (DV)	[AUTO]	[ON]
Copy only portions recorded in HDV format	HDV	HDV	—* ³		
	DVCAM (DV)	—* ²	—* ³	[HDV]	[OFF]
Copy only portions recorded in DVCAM (DV) format	HDV	—* ²	—* ²		
	DVCAM (DV)	DVCAM (DV)	DVCAM (DV)	[DV]	[OFF]

*¹ Recording device compliant with the HDV1080i specification.

*² The tape advances, but no video or sound is recorded (blank).

*³ Picture is not recognized (no recording is made).

🔊 Notes

- When [VCR HDV/DV] is set to [AUTO], and the signal switches between HDV and DVCAM (DV) formats, the picture and sound are interrupted temporarily.
- When the recorder is HVR-Z7E/Z7P, set [VCR HDV/DV] to [AUTO] (p. 83).
- When the player and the recorder are both HDV1080i compatible devices such as HVR-Z7E/Z7P and connected with the i.LINK cable, after pausing or stopping and then resuming the recording, the images will be a bit choppy or rough at that point.
- Set [DISP OUTPUT] to [LCD PANEL] (the default setting) when connecting with an A/V connecting cable (p. 83).

When connecting with the A/V connecting cable with S VIDEO (optional)

Connect with S VIDEO jack instead of the video plug (yellow). This connection produces pictures more faithfully. This connection produces higher quality DVCAM (DV) format pictures. The audio will not be output when you connect with the S VIDEO cable alone.

Dubbing to another device

1 Prepare your camcorder for playback.

Insert the recorded cassette.
Slide the POWER switch to VCR.

Set [DOWN CONVERT] according to the playback device (TV, etc.) (p. 85).

2 Prepare your VCR/DVD device for recording.

When dubbing to the VCR, insert a cassette for recording.
When dubbing to the DVD recorder, insert a DVD for recording.

If your recording device has an input selector, set it to the appropriate input (such as video input1 and video input2).

3 Connect your VCR/DVD device to your camcorder as a recording device.



See page 94 for connection details.

4 Start playback on the camcorder, and recording on the VCR/DVD device.



Refer to the operating instructions supplied with your recording device for details.

5 When dubbing is complete, stop your camcorder and the VCR/DVD device.

Notes

- The following cannot be output via the  HDV/DV interface (i.LINK):
 - Indicators
 - Titles that are recorded on other camcorders
- Pictures recorded in the HDV format are not output from the  HDV/DV interface (i.LINK) jack during playback pause or in any playback mode other than normal playback.
- Note the following when connecting with an i.LINK cable:
 - The recorded picture becomes rough when a picture is paused on your camcorder while recording to a VCR/DVD device.
 - Data codes (date/time/camera settings data) may not be displayed or recorded depending on the device or application.
 - You cannot record the picture and sound separately.
- When dubbing to a DVD recorder from your camcorder through an i.LINK cable, you may not operate your camcorder on your DVD recorder even if its instruction manual says you can. If you can set the input mode to HDV or DV on your DVD recorder and can input/output pictures, follow the steps in "Dubbing to another device."

Tips

- To record the date/time and camera settings data when connected by the A/V connecting cable, display them on the screen.
- When you use an i.LINK cable, the video and sound signals are transmitted digitally, producing high quality pictures.
- When an i.LINK cable is connected, the format of the output signal (HDVout  or DVout ) will be indicated on the LCD screen of your camcorder.

Recording pictures from a VCR i.LINK

You can record pictures from a VCR on a tape. You can record a scene as a still image on a "Memory Stick Duo." You can record pictures in the HDV format by connecting an HDV1080i specification compatible device. Be sure to insert a cassette or a "Memory Stick Duo" for recording in your camcorder beforehand.

You can connect your camcorder to a VCR device using an i.LINK cable.

Connect your camcorder to the wall socket using the supplied AC Adaptor/Charger for this operation (p. 14). Refer also to the instruction manuals supplied with the devices to be connected.

Notes

- You need an i.LINK cable for this operation.
- You cannot perform this operation with the A/V connecting cable.
- Your camcorder has a 6-pin i.LINK terminal. Select a cable that fits the terminal on the device to be attached.
- Your camcorder can only record from a PAL source. For example, French video or TV programs (SECAM) cannot be recorded correctly. See page 120 for details on TV color systems.
- If you use a 21-pin adaptor to input PAL source, you need a dual direction 21-pin adaptor (optional).

HDV1080i compatible device



→ HD quality

AV device with i.LINK jack

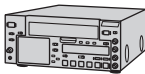

→ SD quality

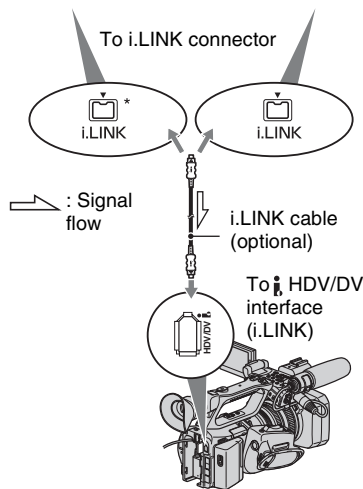

* An i.LINK jack which is compatible with HDV1080i specification is required.

Recording movies



1 Set the **POWER** switch to **VCR**.

2 Set the input signal of your camcorder.

Set [VCR HDV/DV] to [AUTO] when recording from an HDV format compatible device.



Set [VCR HDV/DV] to [DV] or [AUTO] when recording from a DVCAM (DV) format compatible device (p. 83).

3 Connect your VCR as a player to your camcorder.

When an i.LINK cable is connected, the format of the input signal (**HDV IN**  or **DV IN** ) will be indicated on the LCD screen of your camcorder (This indicator may appear on the screen of the playback device but it will not be recorded).

4 Insert a cassette into the VCR.

5 Set your camcorder to recording pause.

While pressing  (PAUSE), press both  REC (record) buttons simultaneously.

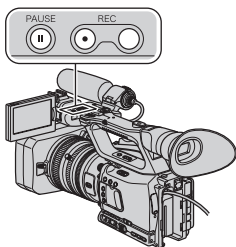



6 Start playing the cassette on your VCR.

The picture played on the VCR appears on the LCD screen of your camcorder.

7 Press (PAUSE) again at the point you want to start recording.

8 Press (STOP) to stop recording.

Notes

- You cannot record TV programs from the  HDV/DV interface (i.LINK).
- User bits are not recorded when dubbing from a DVCAM (DV) device via an i.LINK cable.
- You can record pictures from DV devices only in the DVCAM (DV) format.
- Note the following when connecting with an i.LINK cable:
 - The recorded picture becomes rough when a picture is paused on your camcorder while recording to a VCR.
 - You cannot record the picture and sound separately.
 - If you pause or stop the recording and restart it, the picture may not be recorded smoothly.
- If video signals inputted to your camcorder via the  HDV/DV jack experience the phenomenon of jittering (variation in frequency), that jittering is transmitted to the video signals outputted from the COMPONENT OUT jack and A/V OUT jack. When you monitor a movie on a TV connected to your camcorder via the COMPONENT OUT jack or A/V OUT jack, images may be distorted or not be displayed. Jittering will not affect recording of the movie on a tape with your camcorder but may affect recording of the movie with another VCR connected to your camcorder via the COMPONENT OUT jack or A/V OUT jack.

Tips

- When a 4:3 video signal is input, it appears with black bands on the right and left sides of the screen of your camcorder.

Recording still images

Be sure to insert a “Memory Stick Duo” for recording in your camcorder beforehand, and assign [PHOTO] to any of ASSIGN buttons (p. 43).

1 Perform steps 1 to 4 in “Recording movies.”

2 Start playing the cassette.

The pictures on the VCR appear on the screen of your camcorder.

3 Press the ASSIGN button to which [PHOTO] is assigned or the PHOTO button on the remote commander at the scene you want to record.

⚙ Notes

- The image size is 1.2M when capturing a still image from a movie recorded and played back in the HDV format. The image size is 0.2M when capturing a still image from a movie recorded and played back in the DVCAM (DV) and widescreen (16:9) formats, or VGA (0.3M) when the movie is recorded and played back in the DVCAM (DV) and 4:3 formats.

Copying movies on a tape to a computer

Connect your camcorder to the computer with an i.LINK cable.

The computer needs to have an i.LINK connector and be installed with editing software that can copy video signals. The software required depends on the format of the recorded pictures and the format for copying to the computer (HDV or DVCAM (DV)) as shown in the table below.

Recorded format	Format for copying to the computer	Required software
HDV	HDV	Editing software capable of copying HDV signal
HDV	DVCAM (DV)	Editing software capable of copying DVCAM (DV) signal
DVCAM (DV)	DVCAM (DV)	Editing software capable of copying DVCAM (DV) signal

⚙ Notes

- The  HDV/DV jack of your camcorder does not have a power-supply function.
- You cannot copy movies using a USB cable.
- Refer to the operating instructions of the software for the details on image copying.
- Refer to the operating instructions of the editing software for the recommended connection.
- Some editing software on the computer may not work correctly.
- You cannot change format DVCAM (DV) to HDV.

The required menu settings vary depending on the recorded images and the format (HDV or DVCAM (DV)) to be copied to the computer.

Recorded format	Format for copying to the computer	Menu setting*
HDV	HDV	[VCR HDV/DV] → [HDV] [i.LINK SET] → [HDV → DV CONV] → [OFF]
HDV	DVCAM (DV)	[VCR HDV/DV] → [HDV] [i.LINK SET] → [HDV → DV CONV] → [ON]
DVCAM (DV)	DVCAM (DV)	[VCR HDV/DV] → [DV] [i.LINK SET] → [HDV → DV CONV] → [OFF]

* See page 64 for menu settings.

💡 Tips

- To copy HDV format images as they are without changing their format, an HDV compatible environment is required. For details, refer to your software instruction manual or contact the software manufacturer.
- To play movies by a regular DVD player, you need to create DVD video in the SD format. The DVD video is not in the HDV format.

Step 1 Connect an i.LINK cable

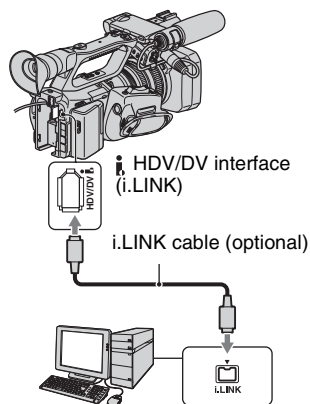

Notes on connecting to the computer

- Connect the i.LINK cable to the computer first, then to your camcorder. Connecting in the opposite order may cause static electricity to build up, resulting in a malfunction of your camcorder.
- The computer may freeze or may not recognize the signal from your camcorder in the following situations.
 - Connecting your camcorder to a computer that does not support the video signal formats appearing on the LCD screen of your camcorder display (HDV or DVCAM (DV)).
 - Changing [VCR HDV/DV] (p. 83) and [i.LINK SET] (p. 86) settings while connected with an i.LINK cable.
 - Changing [REC FORMAT] setting while connected with an i.LINK cable with the POWER switch set to CAMERA (p. 83).
 - Changing the POWER switch position while connected with an i.LINK cable.
- The format (HDV or DVCAM (DV)) of input/output signal appears on the LCD screen of your camcorder while connected with an i.LINK cable.

Step:2 Copying the movies

Use the supplied AC Adaptor/Charger to obtain AC power (p. 14).

- ① Prepare editing software (not provided).
- ② Turn on your computer.
- ③ Insert a tape into your camcorder and set the POWER switch to VCR.
- ④ Set the menu of your camcorder.
The menu settings vary depending on the copying image.
- ⑤ Copy images to the computer with your software.

Notes

- If images are copied in HDV format but are not recognized, your editing software may not support HDV format. Convert the images to DVCAM (DV) format according to step ④ and copy again.
- A tape recorded in DVCAM (DV) format cannot be copied to a computer in HDV format.

Tips

- When images recorded in HDV format are copied to a computer, the file size is about 2GB (almost the same as a DV file) for a 10-minute movie if the video compression format is MPEG2.

When copying the movie in the HDV format from the computer to your camcorder

Set [VCR HDV/DV] to [HDV] and [HDV → DV CONV] of [i.LINK SET] to [OFF] (p. 83, 86).

Notes

- To copy an HDV format movie edited on a computer back onto a tape in HDV format is possible so long as your editing software supports copying HDV movies onto tape. For details, contact the software manufacturer.

When copying the movie in the DVCAM (DV) format from the computer to your camcorder

Set [VCR HDV/DV] to [DV] (p. 83).

Troubleshooting

If you run into any problems using your camcorder, use the following table to troubleshoot the problem. If the problem persists, disconnect the power source and contact your Sony dealer.

- Power sources/LCD screen/Remote Commander...p. 103
- Cassette tapes/"Memory Stick Duo"...p. 104
- Recording...p. 105
- Playback...p. 108
- Connecting to TV...p. 110
- Dubbing/Editing/Connecting to other devices...p. 111
- Connecting to a computer...p. 111

Power sources/LCD screen/Remote Commander

The power does not turn on or abruptly turns off.

- Attach a charged battery pack to the camcorder (p. 14).
- Use the AC Adaptor/Charger to connect to a wall socket (p. 14).

The camcorder does not operate even when the power is set to on.

- Disconnect the AC Adaptor/Charger from the wall socket or remove the battery pack, then reconnect it after about 1 minute.
- Press the RESET button (p. 135) using a sharp-pointed object.

The camcorder gets warm.

- The camcorder may get warmer while you use it. This is not a malfunction.

The remaining battery time indicator does not indicate the correct time.

- Ambient temperature is too high or too low, or the battery pack has not been charged enough. This is not a malfunction.
- Fully charge the battery again. If the problem persists, the battery may be worn-out. Replace it with a new one (p. 14, 120).
- The indicated time may not be correct in certain circumstances. For example, when you open or close the LCD panel, it takes about 1 minute to display the correct remaining battery time.

The battery pack discharges too quickly.

- Ambient temperature is too high or low, or the battery pack has not been charged enough. This is not a malfunction.
- Fully charge the battery again. If the problem persists, the battery may be worn-out. Replace it with a new one (p. 14, 120).

The picture remains on the LCD screen.

- This occurs if you disconnect the DK-415 cable or remove the battery pack without turning off the power first. This is not a malfunction.

The picture in the viewfinder is not clear.

- Move the viewfinder lens adjustment lever until the picture appears clearly (p. 18).
-

The picture in the viewfinder has disappeared.

- If you change [VF POWERMODE] to [AUTO], the finder light remains off while the LCD panel is open (p. 82).
-

The supplied Remote Commander does not function.

- Set [REMOTE CTRL] to [ON] (p. 93).
 - Remove any obstructions between the Remote Commander and the remote sensor.
 - Keep strong light sources, such as sunlight or overhead lighting, away from the remote sensor, otherwise the Remote Commander may not function properly.
 - Insert a fresh battery in the compartment with its +/- terminals matching those of the compartment (p. 136).
-

Another VCR malfunctions when you use the supplied Remote Commander.

- Select a commander mode other than VTR 2 for your VCR.
 - Cover the sensor of your VCR with black paper.
-

Cassette tapes/"Memory Stick Duo"

The cassette cannot be ejected from the compartment.

- Make sure the power source (battery pack or AC Adaptor/Charger) is connected correctly (p. 14).
 - Moisture condensation has occurred inside the camcorder (p. 123).
-

The Cassette Memory indicator or title display does not appear while using a cassette with Cassette Memory.

- This camcorder does not support Cassette Memory, so the indicator does not appear.
-

The remaining tape indicator is not displayed.

- Set [REMAINING] to [ON] to always display the remaining tape indicator (p. 82).
-

The cassette is noisier during rewinding or fast-forwarding.

- When using the DK-415 cable, rewind/fast forward speed increases (compared with battery operation) and therefore increases noise. This is not a malfunction.
-

You cannot delete pictures or format the "Memory Stick Duo."

- The pictures are protected. Release the protect function on your computer, etc.

Recording

The recording does not start when you press the REC START/STOP button.

- Slide the POWER switch to CAMERA (p. 24).
- The tape has reached the end. Rewind it, or insert a new cassette.
- Set the write-protect tab of the cassette to REC or insert a new cassette (p. 116).
- The tape is stuck to the drum due to moisture condensation. Remove the cassette and leave your camcorder for at least 1 hour, then re-insert the cassette (p. 123).
- Set [REC CTL MODE] of [EXT REC CTRL] to other than [EXT ONLY] (p. 86).





The handle zoom does not work.

- Set the handle zoom speed switch to FIX or VAR (p. 27).

You cannot record on the “Memory Stick Duo.”

- Assign [PHOTO] to an ASSIGN button (p. 43).
- The “Memory Stick Duo” is full. Delete unnecessary pictures recorded on the “Memory Stick Duo” (p. 119).
- Format the “Memory Stick Duo” on your camcorder (p. 89) or insert another “Memory Stick Duo” (p. 22).
- You cannot record still images on the “Memory Stick Duo” in the following cases.
 - While executing [FADER]
 - While executing [SMTH SLW REC]
 - When the shutter speed is set to slower than 1/50
 - While using shot transition
 - When [SCAN TYPE] is set to [25]

You cannot record a smooth transition on a tape from the last recorded scene to the next.

- Do not record progressive pictures in different [REC TYPE] settings on the same tape.
- Perform End search (p. 45).
- Do not remove the cassette (the picture will be recorded continuously without a break even when you turn the power off).
- Do not record pictures in the HDV and DVCAM (DV) formats on the same tape.
- Do not record pictures in DVCAM mode and DV SP mode on the same tape.   
- When [QUICK REC] is set to [ON], you cannot record a smooth transition (p. 92). 

The shutter sound is not heard when you record a still image.

- Set [BEEP] to [ON] (p. 92).
- No shutter sound will be outputted during movie recording or while an external device is connected.

End search or last scene review does not work.

- Do not eject the cassette after recording (p. 45).
- There is nothing recorded on the cassette.
- There is a blank section between recorded sections of the tape. This is not a malfunction.

Auto focus does not function.

- Set the focus ring to mode B and press the ASSIGN button to which [FOCUS] is assigned until the automatic focus function is enabled (p. 28, 43).
- Adjust the focus manually if the automatic focus does not work properly (p. 28).

Menu items are grayed out or do not work.

- You cannot select grayed out display items in the current recording/playback situation.
- There are some functions you cannot activate simultaneously. The following list shows examples of unworkable combinations of functions and menu items.

Cannot use	Situation
[BACK LIGHT], [SPOTLIGHT]	Two or more of iris, gain, and shutter speed are set manually.
[AE SHIFT]	Iris, gain, and shutter speed are all set manually.
[CNTRST ENHCR]	During [BACK LIGHT]
[FADER]	No tape is inserted.
[D.EXTENDER]	[REC TYPE] of [HDV PROGRE.] is set to [PROGRESSIVE]. [REC TYPE] of [HDV PROGRE.] is set to [INTERLACE] and [SCAN TYPE] is set to [25]. [SCAN TYPE] of [DV PROGRE.] is set to [25].
[ZEBRA], [PEAKING], [CAM DATA DSP], [HISTOGRAM]	During [COLOR BAR]
[SMTH SLW REC]	[REC TYPE] of [HDV PROGRE.] is set to [PROGRESSIVE]. [REC TYPE] of [HDV PROGRE.] is set to [INTERLACE] and [SCAN TYPE] is set to [25]. [SCAN TYPE] of [DV PROGRE.] is set to [25]. [REC CTL MODE] of [EXT REC CTRL] is set to [EXT ONLY]. During [COLOR BAR]
[MARKER]	During [DATE REC]
[LCD BL LEVEL], [VF B.LIGHT]	During using AC power source
[FOCUS MACRO]	A Carl Zeiss lens is mounted, and the focus ring is set to mode B. A Carl Zeiss lens is not mounted.
[STEADYSHOT], [FLANGE BACK]	A Carl Zeiss lens is not mounted.

Cannot use	Situation
[TC LINK]	Your camcorder is not connected to an external device via an i.LINK cable.
[TC COUNTUP]	[TC MAKE] is set to [REGENERATE].
[UB-DATE/TC-TIME]	[TC MAKE] is set to [REGENERATE]. [TC RUN] is set to [REC RUN]. [UB TIME REC] is set to [ON]. Date and time are not set.
[WORLD TIME], [DATE REC]	Date and time are not set.
[x.v.Color]	[REC FORMAT] is set to [DV].
[ECS FREQ.]	The shutter speed is not set to the ECS .
[INTERVAL REC]	[REC CTL MODE] of [EXT REC CTRL] is set to [EXT ONLY]. [REC TYPE] of [HDV PROGRE.] is set to [PROGRESSIVE]. [REC TYPE] of [HDV PROGRE.] is set to [INTERLACE] and [SCAN TYPE] is set to [25]. [SCAN TYPE] of [DV PROGRE.] is set to [25].
[DV FRAME REC]	[REC CTL MODE] of [EXT REC CTRL] is set to [EXT ONLY].
[EXT REC CTRL]	During [SMTH SLW REC] During [INTERVAL REC] During [DV FRAME REC]

Shutter speed, gain, white balance or iris cannot be adjusted manually.

- Set the AUTO/MANUAL switch to MANUAL.

Tiny spots in white, red, blue, or green appear on the screen.

- This phenomenon appears when using a slow shutter speed (p. 31). This is not a malfunction.

The subjects passing by the frame very fast appear crooked.

- This is called the focal plane phenomenon. This is not a malfunction. Because of the way that the image device (CMOS sensor) reads out image signals, the subjects passing by the frame rapidly might appear crooked depending on the recording conditions.

The screen picture is bright, and the subject does not appear on the screen.

- Set [BACK LIGHT] to [OFF].
- Set [HYPER GAIN] to [OFF].

The screen picture is dark, and the subject does not appear on the screen.

- Press and hold the DISPLAY/BATT INFO button for a few seconds to turn on the backlight (p. 18).

Horizontal stripes appear on the image.

- This occurs when recording pictures under a fluorescent lamp, sodium lamp, or mercury lamp. This is not a malfunction. This can be improved by changing the shutter speed (p. 31).

Black bands appear when you record a TV screen or computer screen.

- This can be improved by adjusting the shutter speed in the extended clear scan (ECS) range (p. 31).

Fine patterns flicker, diagonal lines look jagged.

- Adjust [DETAIL] to [0] side (p. 39).

Playback

If you are playing back pictures stored on a “Memory Stick Duo,” refer also to the Cassette tapes/“Memory Stick Duo” section (p. 104).

You cannot play back tape.

- Slide the POWER switch to VCR.
- Rewind the tape (p. 50).

Image data stored on a “Memory Stick Duo” cannot be played back correctly.

- Image data cannot be played back if you have modified file names or folders, or have edited the data on a computer (In this case, the file name flashes). This is not a malfunction (p. 120).
- Pictures recorded on other devices may not be played back correctly. This is not a malfunction.

The data file name is displayed incorrectly, or flashing.

- The file is damaged.
- The file format is not supported on your camcorder (p. 116).
- Only the file name is displayed if the directory structure does not conform to the universal standard.

Horizontal lines appear on the picture. The displayed pictures are not clear or do not appear.

- Video head is dirty. Clean the head using the cleaning cassette (optional) (p. 124).

You cannot hear the sound recorded with 4CH microphone recording on another camcorder.

- Set [DV AUDIO MIX] for the DVCAM (DV) format 4-ch recording (p. 78).
- You cannot reproduce the sound recorded in CH3 and CH4 on your camcorder for the HDV format 4-ch recording.

No sound or only a low sound is heard.

- Turn up the volume (p. 51).
- Set [DV AUDIO MIX] (p. 78).
- Pictures recorded using [SMTH SLW REC] do not have sounds.

The picture or sound breaks off.

- The tape was recorded in both of the HDV and DVCAM (DV) formats. This is not a malfunction.

The movies freeze for a while, or the sound breaks off.

- This occurs if the tape or video head is dirty (p. 124).
- Use the Sony mini DV cassette tape.

“---” is displayed on the screen.

- The tape you are playing back was recorded without setting the date and time.
- A blank section on the tape is being played back.
- The data code on a tape with a scratch or noise cannot be read.
- A movie recorded in the extended clear scan (ECS) range is being played back.
- When a non-Carl Zeiss lens is attached, the iris value cannot be displayed.

Noises appear and [NTSC] or [60] is displayed on the screen.

- The tape was recorded in a TV color system other than that of your camcorder (PAL). This is not a malfunction.

Date Search does not work correctly.

- Be sure to record more than 2 minutes after the date changed. If one day's recording is too short, your camcorder may not accurately find the point where the recording date changes.
- There is a blank section between recorded sections of the tape. This is not a malfunction.

No picture appears during End search, Rec review or Last scene review.

- The tape was recorded in both HDV and DVCAM (DV) formats. This is not a malfunction.

New sound added to a recorded tape on another camcorder is not heard.**DVCAM DV SP**

- Adjust [DV AUDIO MIX] from [CH1,CH2] (original sound) side until the sound is heard appropriately (p. 78).

2/2-\$T appears on the LCD screen.

- This appears when you play back a tape recorded on other recording devices using a 4ch microphone. This camcorder does not comply with the 4ch microphone recording standard.

Connecting to TV

You cannot view the picture on the TV connected with the i.LINK cable.

- You cannot view the picture in the HD (high definition) quality on the TV if an i.LINK jack of the TV is not compatible with the HDV1080i specification (p. 57). Refer to the instruction manuals supplied with your TV.
- Down convert the pictures recorded in HDV format and play back in DVCAM (DV) format (SD image quality) (p. 86).
- Connect the TV with another connecting cable, and play back pictures (p. 57).

You cannot hear the sound on the TV connected with the S VIDEO plug (S VIDEO channel) or component video plug.

- If you are using an S VIDEO plug or component video plug, make sure the red and white plugs of the A/V connecting cable are also connected (p. 57).

You cannot view the picture or hear the sound on the TV connected with the component video cable.

- Set [COMPONENT] according to the requirements of the connected device (p. 85).
- When you are using the component video cable, make sure the red and white plugs of the A/V connecting cable are connected (p. 57).

You cannot view the picture or hear the sound on the TV connected with the HDMI cable.

- Pictures in the HDV format are not output from the HDMI OUT jack, if copyright protection signals are recorded in the pictures.
- DVCAM (DV) format pictures input to the camcorder via i.LINK cable (p. 98) cannot be output.
- This occurs if you record on a tape in both HDV and DVCAM (DV) formats. Disconnect and connect the HDMI cable, or slide the POWER switch to turn on your camcorder again.

The picture appears distorted on the 4:3 TV.

- This happens when viewing a picture recorded in 16:9 (wide) mode on a 4:3 TV. Select the down conversion type from one of the following menus, depending on the recording format.
 - If the recording format is HDV, select from [DOWN CONVERT] in [VIDEO OUT] (p. 85).
 - If the recording format is DVCAM (DV), select from [DV WIDE CONV] in [VIDEO OUT] (p. 85)

Black zone appears at top and bottom of a 4:3 TV screen.

- This happens when viewing a picture recorded in the 16:9 (wide) mode on a 4:3 TV. This is not a malfunction.

Dubbing/Editing/Connecting to other devices

Pictures from connected devices cannot be zoomed.

- You cannot zoom pictures from connected devices on your camcorder.

Time code and other information appear on the display of the connected device.

- Set [DISP OUTPUT] to [LCD PANEL] while connected with an A/V connecting cable (p. 83).

You cannot dub correctly using the A/V connecting cable.

- The A/V connecting cable is not connected properly.
Make sure that the A/V connecting cable is connected to the input jack of the other device for dubbing a picture from your camcorder.

When connected using an i.LINK cable, no picture appears on the monitor screen during dubbing.

- Set [VCR HDV/DV] according to the requirements of the connected device (p. 83).

You cannot add sound to the recorded tape.

- You cannot add sound to the recorded tape on this unit.

You cannot dub correctly using the HDMI cable.

- You cannot dub pictures using the HDMI cable.

When you copy a movie shot in wide (16:9) format using an i.LINK cable, the screen stretches vertically.

- You cannot output the aspect ratio setting using an i.LINK cable. Set the aspect ratio of the TV instead.
- Connect using an A/V connecting cable instead.

Connecting to a computer

The computer does not recognize your camcorder.

- Disconnect the cable from the computer, then connect it again securely.
- Disconnect the cable from the computer, restart the computer, then connect the computer to your camcorder correctly.

You cannot view or copy a movie recorded on a tape to a computer.

- Disconnect the cable from the computer, then connect it again.
- You need the editing software (optional) to copy a movie recorded on a tape to your computer (p. 100).

Your computer freezes.

- Set [VCR HDV/DV] correctly according to the connected device (p. 83).
- Disconnect the cable from your computer and camcorder. Reboot your computer, and connect your computer and camcorder following the steps in the correct order (p. 101).

Warning indicators and messages

Self-diagnosis display/Warning indicators

When an error occurs, a warning indicator appears on the LCD screen or in the viewfinder.

You can fix some problems associated with the symptoms yourself. If the problem persists even after you have tried a couple of times, contact your Sony dealer or local authorized Sony service facility.

C:(or E:) □□:□□ (Self-diagnosis display)

C:04:□□

- The battery pack is not an “InfoLITHIUM” battery pack. Use an “InfoLITHIUM” battery pack (p. 120).

C:21:□□

- Moisture condensation has occurred. Remove the cassette and leave your camcorder for at least 1 hour, then reinsert the cassette (p. 123).

C:22:□□

- Clean the head using a cleaning cassette (optional) (p. 124).

C:31:□□ / C:32:□□

- Symptoms that are not described above have occurred. Remove and insert the cassette, then operate your camcorder again. Do not perform this procedure if moisture condensation has occurred (p. 123).
- Remove the power source. Reconnect it and operate your camcorder again.
- Change the cassette. Press the RESET button (p. 135), and operate your camcorder again.

E:61:□□ / E:62:□□

- Contact your Sony dealer or local authorized Sony service facility. Inform them of the 5-digit code, which starts from “E.”

101-1001(Warning indicator pertaining to files)

- The file is damaged.
- The file is unreadable (p. 120).

⏏ (Battery level warning)

- The battery pack is nearly used up.
- Depending on the operating environment, or battery conditions, ⏏ may flash, even if there are approximately 5 to 10 minutes remaining.

⏏ (Moisture condensation warning)*

- Eject the cassette, remove the power source, and then leave it for about 1 hour with the cassette lid open (p. 123).

⏏ (Warning indicators pertaining to the tape)

Slow flashing:

- There is less than 5 minutes remaining on the tape.
- No cassette is inserted.*
- The write-protect tab on the cassette is set to lock (p. 116).*

Fast flashing:

- The tape has run out.*

⏏ (Eject cassette warning)*

Slow flashing:

- The write-protect tab on the cassette is set to lock (p. 116).

Fast flashing:

- Moisture condensation has occurred (p. 123).
- The self-diagnosis display code is displayed (p. 113).

* When [BEEP] is set to [ON] (p. 92), you hear a melody when the warning indicators appear on the screen.

Warning indicators and messages (Continued)

Warning messages

If messages appear on the screen, follow the instructions.

Using your camcorder abroad

Power supply

You can use your camcorder in any country/region using the AC Adaptor/Charger supplied with your camcorder within the AC 100 V to 240 V, 50/60 Hz range.

On TV color systems

Your camcorder is PAL system, so its picture can only be viewed on a PAL system TV with an AUDIO/VIDEO input jack.

System	Used in
PAL	Australia, Austria, Belgium, China, Czech Republic, Denmark, Finland, Germany, Holland, Hong Kong, Hungary, Italy, Kuwait, Malaysia, New Zealand, Norway, Poland, Portugal, Singapore, Slovak Republic, Spain, Sweden, Switzerland, Thailand, United Kingdom, etc.
PAL - M	Brazil
PAL - N	Argentina, Paraguay, Uruguay.
SECAM	Bulgaria, France, Guiana, Iran, Iraq, Monaco, Russia, Ukraine, etc.
NTSC	Bahama Islands, Bolivia, Canada, Central America, Chile, Colombia, Ecuador, Guyana, Jamaica, Japan, Korea, Mexico, Peru, Surinam, Taiwan, the Philippines, the U.S.A., Venezuela, etc.

Viewing HDV format pictures recorded in HDV format

You need an HDV1080i compatible TV (or monitor) with a component jack and AUDIO/VIDEO input jack or an HDMI jack. You also need a component video cable and A/V connecting cable or an HDMI cable (optional).

Viewing DVCAM (DV) format pictures recorded in DVCAM (DV) format

You need a TV with the AUDIO/VIDEO input jack. A connecting cable is also needed.

Simple setting of the clock by time difference

When you are abroad, you can easily adjust the clock to the local time by setting the time difference. Select [WORLD TIME], then set the time difference (p. 91).

Maintenance and precautions

HDV format and recording/ playback

Your camcorder is capable of recording in HDV/DVCAM/DV formats.

It is recommended to use a cassette with the Mini DV mark to record in the HDV/DVCAM/DV format.

It is recommended to use a cassette with the **DVCAM** mark to record in the DVCAM format.

Your camcorder is not compatible with the Cassette Memory function.

What is the HDV format?

The HDV format is a video format developed to record and play back digital high definition (HD) video signals on a DV cassette.

Your camcorder adopts the Interlace mode with 1,080 effective scan lines of screen ruling (1080i, number of pixels 1,440 × 1,080 dots).

The video bit rate for recording is about 25 Mbps.

i.LINK is adopted for the digital interface, enabling a digital connection with an HDV compatible TV or computer.

- HDV signals are compressed in MPEG2 format, which is adopted in BS (broadcast satellite) digital, terrestrial digital HDTV broadcastings, in Blu-ray Disc recorders, etc.

Playback

- Your camcorder can play back pictures in both the DVCAM (DV) format and HDV1080i specification.
- Your camcorder can play back pictures recorded in the HDV 720/30p format, but cannot output it from the  HDV/DV interface (i.LINK).

To prevent a blank section from being created on the tape

Go to the end of the recorded section using [END SEARCH] (p. 45) before you begin the next recording when you have played back the tape.

Copyright signal

■ When you play back

If the cassette you play back on your camcorder contains copyright signals, you cannot copy it to a tape in another video camera connected to your camcorder.

■ When you record

You cannot record software on your camcorder that contains copyright control signals for copyright protection of software. [Cannot record due to copyright protection.] appears on the LCD screen, or on the viewfinder if you try to record such software. Your camcorder does not record copyright control signals on the tape when it records.

Audio mode

The DVCAM format has 2 audio modes.

- You cannot dub sound onto a recorded tape with your camcorder.

■ FS32K (12-bit) mode

The original sound is recorded in channels 1 and 2, and the new sound in channels 3 and 4. The balance between channels 1/2 and channels 3/4 can be adjusted by selecting [DV AUDIO MIX] in the menu settings during playback. If you select [MIX], the sounds of channel 1/2 and channel 3/4 are synthesized to be output.

■ FS48K (16-bit) mode

The original sound can be recorded in high quality using 2 channels. The audio mode can be indicated on the LCD screen or in the viewfinder.

Notes on use

■ When not using your camcorder for a long time

Remove the cassette and store it.

■ To prevent accidental erasure

Slide the write-protect tab on the cassette to set it to SAVE.



REC: The cassette can be recorded.

SAVE: The cassette cannot be recorded (write-protected).



■ When labeling the cassette

Be sure to place the label only on the locations shown in the following illustration so as not to cause a malfunction of your camcorder.

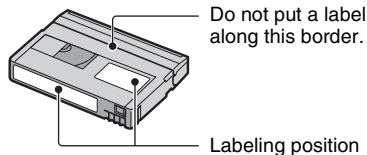

■ After using the cassette

Rewind the tape to the beginning to avoid distortion of the picture or the sound. The cassette should then be put in its case, and stored in an upright position.

■ When cleaning the gold-plated connector

Generally, clean the gold-plated connector on a cassette with a cotton-wool swab after every 10 times it has been ejected. If the gold-plated connector on the cassette is dirty or dusty, the remaining tape indicator may not show correctly.

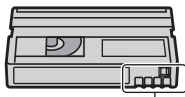

Gold-plated connector

On Sony HDV1080i compliant TVs

HDV1080i

An HDV format compatible TV with the component input jack is required to view playback pictures recorded in the HDV format.

Compatibility of the DVCAM/DV formats

The DVCAM format was developed as a more reliable and higher-end format than the consumer DV format. Explained here are the differences, compatibility, and limitations on editing for the DVCAM and DV formats.

Differences between the DVCAM and DV formats

Specification	DVCAM	DV
TRACK Pitch	15 μ m	10 μ m
Audio sampling frequency	12 bit:32 kHz 16 bit:48 kHz	12 bit:32 kHz 16 bit:48 kHz 44.1 kHz 48 kHz
Audio recording mode*	Lock mode	Lock/Unlock mode

* There are 2 modes for audio recording, lock mode and unlock mode. In lock mode, the sampling frequencies of audio and video are synchronized. Therefore, lock mode is more effective than unlock mode in digital processing and smooth transition during audio editing.

Maintenance and precautions (Continued)

Mini DVCAM and mini DV cassettes

The recording format of the picture is defined according to the recorder's format as described below.

Recorder's format	Cassette's format	Recording format
DVCAM	DVCAM DV	DVCAM
DV	DVCAM DV	DV

Notes

- This camcorder complies with the DVCAM format. Though mini DV cassettes can be used for recording, we recommend you use mini DVCAM cassettes to get the most out of the high reliability of the DVCAM format.
- The recording time of mini DV cassettes is 1/3 shorter than that indicated on mini DV cassettes when recorded in the DVCAM format.

Compatibility on playback

Tape	On DV video equipment	On DVCAM video equipment
DV formatted	Can be played back	Can be played back only when recorded in SP mode
DVCAM formatted	Can be played back on some equipment	Can be played back

Compatibility on editing using DV jacks

When this camcorder is connected to other digital video equipment using an i.LINK cable, the recording format of edited tapes is defined according to the source tape and the recorder's format as described below. Playback or editing using the edited tape may be limited depending on dubbing operation. Start dubbing after reading "Limitations on editing" (p. 119).

Source tape	Player's format	Recorder's format	Recording format
DV formatted (SP mode only)	DVCAM	DVCAM DV	DVCAM ¹⁾ DV
DV formatted	DV	DVCAM DV	DVCAM DV
DVCAM formatted ²⁾	DVCAM	DVCAM DV	DVCAM DV
DVCAM formatted ²⁾	DV ³⁾	DVCAM	DVCAM (Compatibility depends on models.) DV DV

¹⁾ When using mini DVCAM video equipment to perform DV dubbing of a tape recorded in DV format, the tape produced will be in the DVCAM format which the time code format will be partly misadjusted. (there will be no effect on the recorded picture except in certain cases.)

²⁾ If the tape that is to be dubbed is in the DVCAM format as in 1), the tape produced will be in the DVCAM format and the time code format will be partly misadjusted.

³⁾ Some mini DV video equipment may be able to play back a DVCAM-formatted tape. Even if the tape is played back, quality of the playback cannot be guaranteed. The time code format will be partly misadjusted.

Notes

- If you use tapes as in 1) to 3) above for editing, the functions may be limited regardless of the format of players and recorders.

Limitations on editing

You may find the following limitations when editing a tape produced by dubbing or editing using the HDV/DV Interface

i (i.LINK) jack:

- Due to the difference in track pitch, you cannot record or edit on DV-formatted tapes using mini DVCAM video equipment.
- Depending on the DVCAM video equipment used, you may not be able to edit DVCAM formatted tapes if the audio recording mode is unlock mode. In this case, dub using audio/video jacks.

About the “Memory Stick”

A “Memory Stick” is a compact, portable IC recording medium with a large data capacity.

You can use the following types of “Memory Stick” listed below on the camcorder. However, we do not guarantee the operation of all types of “Memory Stick” on your camcorder. (See the list below for more details.)

Types of “Memory Stick”	Recording /Playback
“Memory Stick Duo” (with MagicGate)	○
“Memory Stick PRO Duo”	○
“Memory Stick PRO-HG Duo”	○

- This product does not support high speed data transfer via a parallel interface.
- This product cannot record or play data that uses “MagicGate” technology. “MagicGate” is a copyright protection technology that records and transfers the contents in an encrypted format.
- This product is compatible with “Memory Stick Micro” (“M2”). “M2” is the abbreviation for the “Memory Stick Micro.”
- Still image format: Your camcorder compresses and records image data in the JPEG (Joint

Photographic Experts Group) format. The file extension is “.JPG.”

- A “Memory Stick Duo” formatted by a computer (Windows OS/Mac OS) does not have guaranteed compatibility with your camcorder.
- Data read/write speed may vary depending on the combination of the “Memory Stick Duo” and “Memory Stick Duo” compliant product you use.
- You can prevent accidental erasure of images when you slide the write-protect tab on the “Memory Stick Duo” with a small tapered object, to the write-protect position.
- Damaged or lost image data will not be compensated for, and may occur in the following cases:
 - If you eject the “Memory Stick Duo,” turn the power off on your camcorder, or remove the battery pack for replacement while your camcorder is reading or writing image files on the “Memory Stick Duo” (while the access lamp is lit or flashing).
 - If you use the “Memory Stick Duo” near magnets or magnetic fields.
- It is recommended to make a back-up of important data on the hard disk of a computer.
- Be careful not to apply excessive force when writing on a memo area on a “Memory Stick Duo.”
- Do not attach a label or the like on a “Memory Stick Duo” or a Memory Stick Duo adaptor.
- When you carry or store a “Memory Stick Duo,” put it in its case.
- Do not touch, or allow metallic objects to come into contact with the terminals.
- Do not bend, drop or apply strong force to the “Memory Stick Duo.”
- Do not disassemble or modify the “Memory Stick Duo.”
- Do not let the “Memory Stick Duo” get wet.
- Be careful to keep “Memory Stick Duo” media out of the reach of small children. There is danger that a child might swallow it.
- Do not insert anything other than a “Memory Stick Duo” into the Memory Stick Duo slot. Doing so may cause a malfunction.
- Do not use or keep the “Memory Stick Duo” in the following locations:
 - Places subject to extremely high temperature, such as a car parked outside in the summer.
 - Places under direct sunlight.

Maintenance and precautions (Continued)

- Places with extremely high humidity or subject to corrosive gases.

■ On the Memory Stick Duo adaptor

- When using a “Memory Stick Duo” with a “Memory Stick” compliant device, make sure to insert the “Memory Stick Duo” into a Memory Stick Duo adaptor.
- When inserting a “Memory Stick Duo” into a Memory Stick Duo adaptor, make sure the “Memory Stick Duo” is inserted facing in the correct direction, then insert it all the way in. Note that improper use may cause a malfunction. Also, if you force the “Memory Stick Duo” into the Memory Stick Duo adaptor in the wrong direction, it may be damaged.
- Do not insert a Memory Stick Duo adaptor without a “Memory Stick Duo” attached. Doing so may result in malfunctions of the unit.

■ On a “Memory Stick PRO Duo”

- The maximum memory capacity of a “Memory Stick PRO Duo” that can be used on your camcorder is 8 GB.
- This unit does not support high speed data transfer.

Notes on using “Memory Stick Micro”

- To use a “Memory Stick Micro” with the camcorder, you need a Duo-sized M2 Adaptor. Insert the “Memory Stick Micro” into the Duo-sized M2 Adaptor, then insert the adaptor into the Memory Stick Duo slot. If you insert a “Memory Stick Micro” into the camcorder without using a Duo-sized M2 Adaptor, you might not be able to remove it from the camcorder.
- Do not leave the “Memory Stick Micro” within the reach of small children. They might accidentally swallow it.

On image data compatibility

- Image data files recorded on a “Memory Stick Duo” by your camcorder conform to the “Design rule for Camera File system” universal standard established by the JEITA (Japan Electronics and Information Technology Industries Association).
- On your camcorder, you cannot play back still images recorded on other devices (DCR-TRV900E or DSC-D700/D770) that do not

conform to the universal standard. (These models are not sold in some regions.)

- If you cannot use a “Memory Stick Duo” that has been used with another device, format it with your camcorder (p. 89). Note that formatting erases all information on the “Memory Stick Duo.”
- You may not be able to play back images with your camcorder:
 - When playing back image data modified on your computer.
 - When playing back image data recorded with other devices.

About the “InfoLITHIUM” battery pack

This unit is compatible with an “InfoLITHIUM” battery pack (L series). Your camcorder operates only with an “InfoLITHIUM” battery pack. “InfoLITHIUM” L series battery packs have the  mark.

What is an “InfoLITHIUM” battery pack?

An “InfoLITHIUM” battery pack is a lithium-ion battery pack that has functions for communicating information related to operating conditions between your camcorder and an supplied AC Adaptor/Charger.

The “InfoLITHIUM” battery pack calculates the power consumption according to the operating conditions of your camcorder, and displays the remaining battery time in minutes.

With an AC Adaptor/Charger, the remaining battery time and charging time appear.

To charge the battery pack

- Be sure to charge the battery pack before you start using your camcorder.
- We recommend charging the battery pack in an ambient temperature of between 10 °C to 30 °C (50 °F to 86 °F) until the charge lamp of the AC Adaptor/Charger turns off. If you charge the

battery pack outside of this temperature range, you may not be able to charge it efficiently.

To use the battery pack effectively

- Battery pack performance decreases when the surrounding temperature is 10 °C (50 °F) or below, and the length of time you can use the battery pack becomes shorter. In that case, do one of the following to use the battery pack for a longer time.
 - Put the battery pack in a pocket to warm it up, and insert it in your camcorder right before you start taking shots.
 - Use a large capacity battery pack: NP-F770/F970 (optional).
- Frequent use of the LCD screen or a frequent playback, fast forward or rewind operation wears out the battery pack faster. We recommend using a large capacity battery pack: NP-F770/F970.
- Be sure to set the POWER switch to OFF when not recording or playing back on your camcorder. The battery pack is also consumed when your camcorder is in recording standby or playback pause.
- Have spare battery packs ready for two or three times the expected recording time, and make trial recordings before making the actual recording.
- Do not expose the battery pack to water. The battery pack is not water resistant.

About the remaining battery time indicator

- When the power goes off even though the remaining battery time indicator indicates that the battery pack has enough power to operate, charge the battery pack fully again. Remaining battery time will be indicated correctly. Note, however, that the battery indication will not be restored if it is used in high temperatures for a long time, or if left in a fully charged state, or when the battery pack is frequently used. Use the remaining battery time indication as a rough guide only.
- The  mark that indicates low battery flashes even if there are still 5 to 10 minutes of battery time remaining, depending on the operating conditions or ambient temperature.

About storage of the battery pack

- If the battery pack is not used for a long time, fully charge the battery pack and use it up on your camcorder once a year to maintain proper function. To store the battery pack, remove it from your camcorder and put it in a dry, cool place.
- To discharge the battery pack on your camcorder completely, leave your camcorder in tape recording standby until the power goes off (p. 17).

About battery life

- Battery capacity decreases over time and through repeated use. If decreased usage time between charges becomes significant, it is probably time to replace it with a new one.
- Each battery's life is governed by storage, operating and environmental conditions.

About i.LINK

The  HDV/DV (i.LINK) jack on your camcorder is an i.LINK-compliant 6-pin jack. This section describes the i.LINK standard and its features.

What is i.LINK?

i.LINK is a digital serial interface for transferring digital video, digital audio, and other data to other i.LINK-compatible devices. You can also control other devices using the i.LINK.

i.LINK-compatible devices can be connected using an i.LINK cable. Possible applications are operations and data transactions with various digital AV devices.

When two or more i.LINK-compatible devices are daisy-chained with the unit, operation becomes possible from any device in the chain. Note that operation method may vary, or data transactions may not be possible, depending on specifications and characteristics of the connected devices.

Maintenance and precautions (Continued)

🔊 Notes

- Normally, only one device can be connected to this unit with an i.LINK cable. When connecting this unit to an HDV/DV compatible device having two or more  HDV/DV interfaces, refer to the operating instructions of the device to be connected.
- i.LINK is a more familiar term for the IEEE 1394 data transport bus proposed by Sony, and is a trademark approved by many corporations.
- IEEE 1394 is an international standard standardized by the Institute of Electrical and Electronics Engineers.

About the i.LINK Baud rate

i.LINK's maximum baud rate varies according to the device. There are 3 types.

S100 (approx. 100Mbps*)

S200 (approx. 200Mbps)

S400 (approx. 400Mbps)

The baud rate is listed under "Specifications" in the operating instructions of each piece of equipment. It is also indicated near the i.LINK interface on some devices.

The baud rate may differ from the indicated value when the unit is connected to a device with a different maximum baud rate.

* What is Mbps?

Mbps stands for "megabits per second," or the amount of data that can be sent or received in one second. For example, a baud rate of 100 Mbps means that 100 megabits of data can be sent in one second.

To use i.LINK functions on this unit

For details on how to dub when this unit is connected to other video devices having an i.LINK interface, see page 97.

This unit can also be connected to other i.LINK-compatible devices made by Sony (for example, a VAIO series personal computer) as well as to video devices. Some i.LINK compatible video devices, such as Digital Televisions, DVD, MICROMV or HDV recorders/players are

not compatible with this unit. Before connecting to other devices, be sure to confirm whether the device is compatible with an HDV/DV device or not. For details on precautions and compatible application software, refer also to the operating instructions for the device to be connected.

🔊 Notes

- When connecting a device with an i.LINK terminal to your camcorder via an i.LINK cable, switch off the device and unplug it from the power socket before plugging in or unplugging the i.LINK cable.

About x.v.Color

- x.v.Color is a more familiar term for the xvYCC standard proposed by Sony, and is a trademark of Sony.
- xvYCC is an international standard for color space in video. This standard can express a wider color range than the currently used broadcast standard.

About handling of your camcorder

On use and care

- Do not use or store the camcorder and accessories in the following locations.
 - Anywhere extremely hot or cold. Never leave them exposed to temperatures above 60 °C (140 °F), such as under direct sunlight, near heaters or in a car parked in the sun. They may malfunction or become deformed.
 - Near strong magnetic fields or mechanical vibration. The camcorder may malfunction.
 - Near strong radio waves or radiation. The camcorder may not be able to record properly.
 - Near AM receivers and video equipment. Noise may occur.
 - On a sandy beach or anywhere dusty. If sand or dust gets in your camcorder, it may malfunction. Sometimes this malfunction cannot be repaired.
 - Near windows or outdoors, where the LCD screen, the viewfinder, or the lens may be

exposed to direct sunlight. This damages the inside of the viewfinder or the LCD screen.

– Anywhere very humid.

- Operate your camcorder on DC 7.2 V (battery pack) or DC 8.4 V (AC Adaptor).
- For DC or AC operation, use the accessories recommended in these operating instructions.
- Do not let your camcorder get wet, for example, from rain or sea water. If your camcorder gets wet, it may malfunction. Sometimes this malfunction cannot be repaired.
- If any solid object or liquid gets inside the casing, unplug your camcorder and have it checked by a Sony dealer before operating it any further.
- Avoid rough handling, disassembling, modifying, physical shock, or impact such as hammering, dropping or stepping on the product. Be particularly careful of the lens.
- Keep the POWER switch setting to OFF when you are not using your camcorder.
- Do not wrap your camcorder with a towel, for example, and operate it. Doing so might cause heat to build up inside.
- When disconnecting the mains lead, pull it by the plug and not the lead.
- Do not damage the mains lead such as by placing anything heavy on it.
- Keep metal contacts clean.
- Keep the Remote Commander and button-type battery out of children's reach. If the battery is accidentally swallowed, consult a doctor immediately.
- If the battery electrolytic liquid has leaked,
 - consult your local authorized Sony service facility.
 - wash off any liquid that may have contacted your skin.
 - if any liquid gets in your eyes, wash with plenty of water and consult a doctor.

■ When not using your camcorder for a long time

- Periodically turn on the camcorder and play a cassette for about 3 minutes.
- Use up the battery pack completely before storing it.



Moisture condensation

If your camcorder is brought directly from a cold place to a warm place, moisture may

condense inside your camcorder, on the surface of the tape, or on the lens. In this state, the tape may stick to the head drum and be damaged or your camcorder may not operate correctly. If there is moisture inside your camcorder, [Moisture condensation. Eject the cassette] or [Moisture condensation. Turn off for 1H.] appears. The indicator will not appear when the moisture condenses on the lens.

■ If moisture condensation has occurred

None of the functions except cassette ejection will work. Eject the cassette, turn off your camcorder, and leave it for about one hour with the cassette lid open. Your camcorder can be used again when both of the following conditions are met:

- The warning message does not appear when the power is turned on.
- Neither  nor  flashes when a cassette is inserted and the video operation buttons are pressed.

If moisture starts to condense, your camcorder sometimes cannot detect condensation. If this happens, the cassette is sometimes not ejected for 10 seconds after the cassette lid is opened. This is not a malfunction. Do not close the cassette lid until the cassette is ejected.

■ Note on moisture condensation

Moisture may condense when you bring your camcorder from a cold place into a warm place (or vice versa) or when you use your camcorder in a humid place as shown below.

- When you bring your camcorder from a ski slope into a place warmed up by a heating device.
- When you bring your camcorder from an air conditioned car or room into a hot place outside.
- When you use your camcorder after a squall or a shower.
- When you use your camcorder in a hot and humid place.

■ How to avoid moisture condensation

When you bring your camcorder from a cold place into a warm place, put your

Maintenance and precautions (Continued)

camcorder in a plastic bag and seal it tightly. Remove the bag when the air temperature inside the plastic bag has reached the surrounding temperature (after about one hour).

Video head

If you play back a tape recorded in HDV format, the image and sound may freeze for a while (about 0.5 seconds).

This occurs if the HDV signals cannot be recorded or played back correctly because of dirt on the tape or video head. Depending on the cassette, this fairly infrequently occurs even if the cassette is brand new or is not used a lot.

If this freezing point is created while playing back, you can solve this problem and see the pictures by rewinding after slightly forwarding. Such a freezing point cannot be recovered if it was created while recording.

To prevent such a problem, use the Sony mini DV cassette.

- If the following problem occurs, clean the video heads for 10 seconds with the Sony cleaning cassette (optional).
 - Playback pictures do not move.
 - Playback pictures do not appear.
 - The sound breaks off.
 -  Dirty video head. Use a cleaning cassette.] appears on the screen during recording.
 - The following phenomenon occurs in HDV format.



The playback screen pauses.



The playback screen goes blank. (Solid blue screen)

- The following phenomenon occurs in DVCAM (DV) format.



Block-noise appears.



The playback screen goes blank. (Solid blue screen)

- The video heads will be worn after long use. If you cannot obtain a clear image even after using a cleaning cassette (optional), the video heads may be worn out. Please contact your Sony dealer or local authorized Sony service facility to have the video heads replaced.

LCD screen

- Do not exert excessive pressure on the LCD screen, as it may cause damage.
- If your camcorder is used in a cold place, a residual image may appear on the LCD screen. This is not a malfunction.
- While using your camcorder, the back of the LCD screen may heat up. This is not a malfunction.

■ To clean the LCD screen

If fingerprints or dust make the LCD screen dirty, it is recommended you use a soft cloth to clean it. When you use the LCD Cleaning Kit (optional), do not apply the cleaning liquid directly to the LCD screen. Use cleaning paper moistened with the liquid.

On handling the casing

- If the casing is soiled, clean the camcorder body with a soft cloth lightly moistened with water, and then wipe the casing with a dry soft cloth.
- Avoid the following to avoid damage to the finish.
 - Using chemicals such as thinner, benzine, alcohol, chemical cloths, repellent, insecticide and sunscreen.
 - Handling with above substances on your hands.

- Leaving the casing in contact with rubber or vinyl objects for a long period of time.

About care and storage of the lens

- Wipe the surface of the lens clean with a soft cloth in the following instances:
 - When there are fingerprints on the lens surface.
 - In hot or humid locations
 - When the lens is exposed to salty air such as at the seaside.
- Store in a well-ventilated location subject to little dirt or dust.
- To prevent mold, periodically clean the lens as described above. It is recommended that you operate your camcorder about once a month to keep it in optimum state for a long time.

On charging the pre-installed rechargeable battery

Your camcorder has a pre-installed rechargeable battery to retain the date, time, and other settings even when the POWER switch is set to OFF. The pre-installed rechargeable battery is always charged while your camcorder is connected to the wall socket via the AC Adaptor or while the battery pack is inserted. The rechargeable battery will be fully discharged in about **3 months** if you do not use your camcorder at all without the AC Adaptor connected or the battery pack attached. Use your camcorder after charging the pre-installed rechargeable battery. However, even if the pre-installed rechargeable battery is not charged, the camcorder operation will not be affected as long as you are not recording the date.

■ Procedures

Connect your camcorder to a wall socket using the supplied AC Adaptor, and leave it with the POWER switch set to OFF for more than 24 hours.

Removing dust from inside the viewfinder

1 Remove the eye piece of the viewfinder.

Slide down the viewfinder release lever and hold it at the position (①), then lift the eye piece of the viewfinder as indicated with the arrow in the illustration (②).

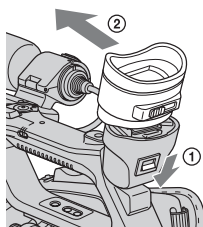

2 Remove dust inside the eye piece and viewfinder with a blower.

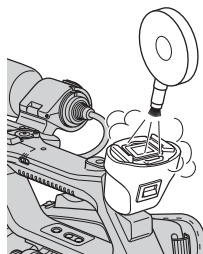

Specifications

System

Video recording system (HDV)

2 rotary heads, Helical scanning system

Video recording system (DVCAM (DV))

2 rotary heads, Helical scanning system

Still image recording system

Exif Ver. 2.2*

Audio recording system (HDV)

Rotary heads, MPEG-1 Audio Layer-2,

Quantization: 16 bits

Fs48kHz (stereo)

transfer rate: 384 kbps

Audio recording system (DVCAM (DV))

Rotary heads, PCM system

Quantization: 12 bits

Fs32kHz (channel 1/2 stereo),

Quantization: 16 bits



Fs48kHz (channel 1/2 stereo)

Video signal

PAL color, CCIR standards

1080/50i specification

Usable cassette

Mini DV cassette with the  mark printed or Mini DVCAM cassette with the  mark printed

Tape speed (HDV)

Approx. 18.812 mm/s

Tape speed (DVCAM)

Approx. 28.218 mm/s

Tape speed (DV SP)

Approx. 18.812 mm/s

Recording/playback time (HDV)

63 min (using a PHDVM-63DM cassette)

Recording/playback time (DVCAM)

41 min (using a PHDVM-63DM cassette)

Recording/playback time (DV SP)

63 min (using a PHDVM-63DM cassette)

Fast forward/rewind time

Approx. 2 min 40 s (using a PHDVM-63DM cassette and rechargeable battery pack)

Approx. 1 min 45 s (using a PHDVM-63DM cassette and AC Adaptor)

Viewfinder

Electric viewfinder (color, black and white)

Picture

1.1cm (0.45 type, aspect ratio 16:9)

Total dot number

1 226 880 (approx. 852 × 3[RGB] × 480)

Image device

6.0 mm (1/3 type) 3CMOS sensor

Recording Pixels (HDV/DV16:9 still recording):

Max. 1.20 Mega (1 440 × 810) pixels**

Gross: Approx. 1 120 000 pixels

Effective (movie, 16:9):

1 037 000 pixels

Effective (movie, 4:3):

778 000 pixels

Effective (still, 16:9):

1 037 000 pixels

Effective (still, 4:3):

778 000 pixels

Lens

Carl Zeiss Vario-Sonnar T*

12 × (Optical), Approx. 18 × (Digital, when [D.EXTENDER] is set to [ON])

Focal length

f=4.4 - 52.8 mm (3/16 - 2 1/8 in.)

When converted to a 35 mm still camera

32.0 - 384 mm (1 5/16 - 15 1/8 in.) (16:9),

39.5 - 474 mm (1 9/16 - 18 3/4 in.) (4:3)

F1.6 - 2.0

Filter diameter: 72 mm (2 7/8 in.)

Color temperature

[AUTO]

 (one push) A/B

[INDOOR] (3 200K)

[OUTDOOR] (5 800K±7 offset levels)

[MANU WB TEMP] (2 300K -

15 000K in 100K steps)

Minimum illumination

1.5 lx (lux) (Fixed Shutter Speed 1/25, auto gain, auto iris) (F 1.6)

* “Exif” is a file format for still images, established by the JEITA (Japan Electronics and Information Technology Industries Association). Files in this format can have additional information such as your camcorder’s setting information at the time of recording.

**Still image resolution is obtained by the unique pixel array of Sony’s ClearVid CMOS Sensor and image processing system (new Enhanced Imaging Processor).

Output connectors

A/V OUT jack

10-pin connector

Video signal: 1 Vp-p, 75 Ω (ohms)

Luminance signal: 1 Vp-p, 75 Ω (ohms)

Chrominance signal: 0.3 Vp-p (burst signal), 75 Ω (ohms)

Audio signal: -10 dBu (at load impedance 47 kΩ (kilohms)), Output impedance with less than 2.2 kΩ (kilohms)

(0 dBu=0.775 Vrms)

COMPONENT OUT jack

Y: 1 Vp-p, 75Ω (ohms), PB/PR, CB/CR:

+/- 350 mV, 75 Ω (ohms)

HDMI OUT jack

TypeA (19-pin)

Input/Output connectors

LANC jack

Stereo mini-minijack (Ø 2.5 mm)

(headphones) jack

Stereo-minijack (Ø 3.5 mm)

LENS jack

12-pin connector

INPUT1/INPUT2 jack

XLR 3-pin, female,

-48 dBu: 3kΩ (kilohms)

+4 dBu: 10kΩ (kilohms)

(0 dBu=0.775 Vrms)

i.LINK DV jack

i.LINK interface (IEEE 1394, 6-pin connector S100)

LCD screen

Picture

8.0 cm (3.2 type, aspect ratio 16:9)

Total dot number

921 600 (1 920 × 480)

General

Power requirements

DC 7.2 V (battery pack)

DC 8.4 V (AC Adaptor)

Average power consumption*

During camera recording using the microphone ECM-XM1 and viewfinder with normal brightness:

HDV recording 7.0 W

DVCAM (DV) recording 6.8 W

During camera recording using the microphone ECM-XM1 and LCD with normal brightness:

HDV recording 7.1 W

DVCAM (DV) recording 6.9 W

Operating temperature

0 °C to 40 °C (32 °F to 104 °F)

Storage temperature

-20 °C to +60 °C (-4 °F to +140 °F)

Specifications (Continued)

Dimensions (approx.)

176 × 199 × 439 mm
(6 15/16 × 7 13/16 × 17 9/32 in.)
(w/h/d)
including the projecting parts
176 × 199 × 439 mm
(6 15/16 × 7 13/16 × 17 9/32 in.)
(w/h/d)
including the projecting parts with the
battery pack (NP-F570)

Mass (approx.)

1.3 kg (2 lb 13 oz) camera body only
2.4 kg (5 lb 4 oz) including the Carl
Zeiss lens (VCL-412BWH)
2.8 kg (6 lb 3 oz) including the battery
pack (NP-F570), cassette (PHDVM-
63DM), Carl Zeiss lens (VCL-
412BWH), lens hood with lens cover
and microphone (ECM-XM1)

* When the HVR-MRC1 is used, the average
power consumption increases about 2.5 W.

AC Adaptor/Charger AC-VQ1050

Power requirements

AC 100 V - 240 V, 50/60 Hz

Power consumption

22 W

Output voltage

DC 8.4 V*

Operating temperature

0 °C to 40 °C (32 °F to 104 °F)

Storage temperature

-20 °C to +60 °C (-4 °F to +140 °F)

Dimensions (approx.)

123 × 53 × 135 mm
(4 7/8 × 2 1/8 × 5 3/8 in.) (w/h/d)
excluding the projecting parts

Mass (approx.)

390 g (13.8 oz) excluding the power
cord

* See the label on the AC Adaptor/Charger for
other specifications.

Rechargeable battery pack NP-F570

Maximum output voltage

DC 8.4 V

Output voltage

DC 7.2 V

Capacity

15.8 Wh (2 200 mAh)

Type

Li-ion

Design and specifications are subject to change
without notice.

On trademarks

- “Memory Stick,”  “Memory Stick Duo,” “**MEMORY STICK DUO**,” “Memory Stick PRO Duo,” “**MEMORY STICK PRO DUO**,” “Memory Stick PRO-HG Duo,” “**MEMORY STICK PRO-HG DUO**,” “Memory Stick Micro,” “MagicGate,” “**MAGIC GATE**,” “MagicGate Memory Stick” and “MagicGate Memory Stick Duo” are trademarks of Sony Corporation.
- “InfoLITHIUM” is a trademark of Sony Corporation.
- “x.v.Colour” is a trademark of Sony Corporation.
- i.LINK and  are trademarks of Sony Corporation.
- Mini  Digital Video Cassette is a trademark.
-  is a trademark.
- Microsoft, Windows, Windows Vista, and Windows Media are trademarks or registered trademarks of U.S. Microsoft Corporation in the U.S. and other countries.
- Macintosh and Mac OS are registered trademarks of Apple Inc. in the U.S. and other countries.
- HDV and the HDV logo are trademarks of Sony Corporation and Victor Company of Japan, Ltd.
- HDMI, HDMI logo, and High-Definition Multimedia Interface are trademarks or registered trademarks of HDMI Licensing LLC.
- Pentium is a trademark or registered trademark of Intel Corporation.
- Adobe, and Adobe Reader are trademarks of Adobe Systems Incorporated.

All other product names mentioned herein may be the trademarks or registered trademarks of their respective companies. Furthermore, TM and “®” are not mentioned in each case in this manual.

Notes on the License

ANY USE OF THIS PRODUCT OTHER THAN CONSUMER PERSONAL USE IN ANY MANNER THAT COMPLIES WITH THE MPEG-2 STANDARD FOR ENCODING VIDEO INFORMATION FOR PACKAGED MEDIA IS EXPRESSLY PROHIBITED WITHOUT A LICENSE UNDER APPLICABLE PATENTS IN THE MPEG-2 PATENT PORTFOLIO, WHICH LICENSE IS AVAILABLE FROM MPEG LA, L.L.C., 250 STEELE STREET, SUITE 300, DENVER, COLORADO 80206.

Identifying parts and controls

The numbers in () are reference pages.

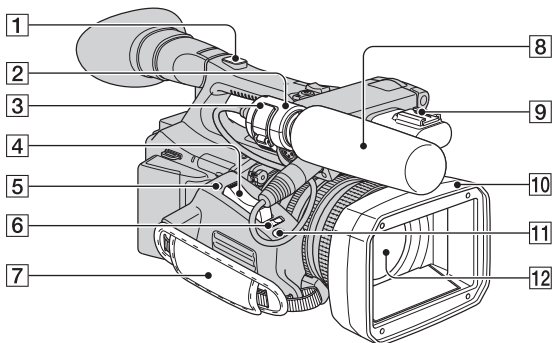

- | | |
|---|--|
| 1 Accessory shoe mount (130) | 7 Grip belt (17) |
| 2 Microphone holder (12) | 8 Microphone (12) |
| 3 Microphone fixing clamper (12) | 9 Accessory shoe adaptor (131) |
| 4 Zoom lever (27) | 10 Lens hood with lens cover (12) |
| 5 EXPANDED FOCUS/L2 button (43) | 11 PUSH AUTO button (30) |
| 6 IRIS switch (30) | 12 Lens (10) |

To mount the accessory shoe

Mount the accessory shoe on the accessory shoe mount as illustrated.

Accessory shoe plate

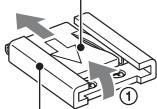

Accessory shoe

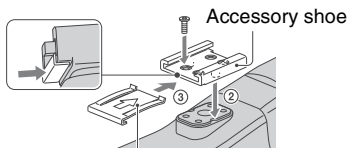

Accessory shoe plate

plate and remove it from the accessory shoe.

- 2** Place the accessory shoe as its protrusions matches recesses of the accessory shoe mount, then fix it to the mount with four screws.
- 3** Insert the accessory shoe plate in the direction of the arrow on the plate surface until the end of the plate engages the end of the shoe.

To remove the accessory shoe

Remove the shoe plate in the same way as step **1** of "To mount the accessory shoe." Loosen the 4 screws and remove the accessory shoe from the accessory shoe mount.

- 1** Lift the edge of the accessory shoe plate and pull it in the direction opposite to that of the arrow on the accessory shoe

To mount the accessory shoe adaptor

Mount the accessory shoe adaptor on the accessory shoe mount as illustrated.

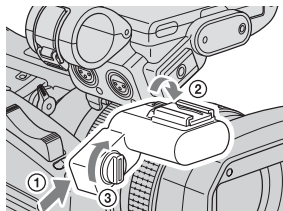

To remove the accessory shoe adaptor

Do the reverse procedure to mounting the accessory shoe adaptor to remove it.

Identifying parts and controls (Continued)

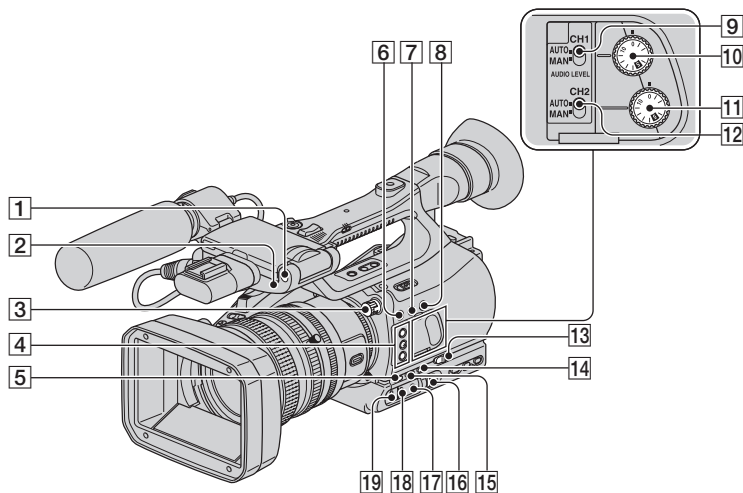

1 Front remote sensor (93)

2 Front recording lamp (92)
The recording lamp flashes if the remaining tape or battery is low.

3 ND filter (30)

4 ASSIGN buttons 1-3* (43)

5 GAIN button (31)

6 ASSIGN 4 button/ZEBRA button (43)

7 ASSIGN 5 button/AE SHIFT button*(43)

8 ASSIGN 6 button/REC REVIEW button (43)

9 AUDIO LEVEL(CH1) switch (41)

10 AUDIO LEVEL(CH1) dial (41)

11 AUDIO LEVEL(CH2) dial (41)

12 AUDIO LEVEL(CH2) switch (41)

13 AUTO/MANUAL switch (41)

14 SHUTTER SPEED button (31)

15 WHT BAL* button (32)

16 SEL/PUSH EXEC dial (20)

17  (one push) button (32)

18 White balance memory switch (32)

19 Gain switch (31)

* The ASSIGN 2 button, ASSIGN 5 button/AE SHIFT button and WHT BAL button have raised tactile dots for your convenience in locating the buttons.

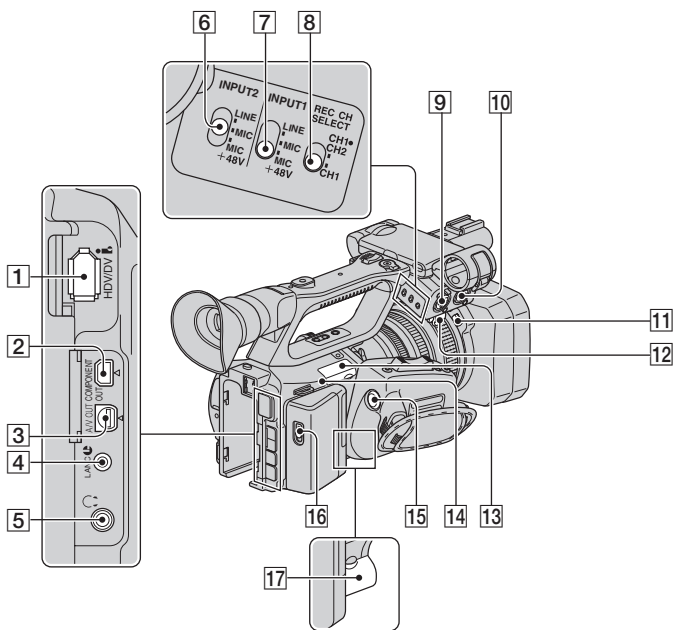

- 1 HDV/DV jack (57)
- 2 COMPONENT OUT jack (57)
- 3 A/V OUT jack (57)
- 4 LANC control jack is used for controlling the tape transport of video device and peripherals connected to it.
- 5 (headphones) jack
- 6 INPUT2 switch (12)
- 7 INPUT1 switch (12)
- 8 REC CH SELECT switch (12)
- 9 INPUT2 jack (12)
- 10 INPUT1 jack (12)
- 11 PUSH (lens hood release) button (12)
- 12 Cable holder (12)
- 13 Memory Stick Duo slot (22)
- 14 Access lamp (22)
- 15 REC START/STOP button (24)
- 16 OPEN/EJECT lever (22)
- 17 LENS jack (10)

Identifying parts and controls (Continued)

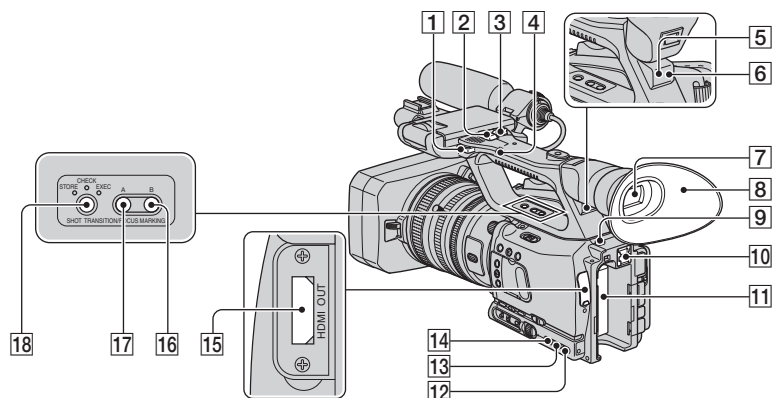

- 1** Hook for shoulder strap (134)
- 2** Handle zoom lever (27)
- 3** REC START/STOP button (24)
- 4** Handle zoom switch (27)
- 5** Rear remote sensor (93)
- 6** Rear recording lamp (92)
The recording lamp flashes if the remaining tape or battery is low.
- 7** Viewfinder (18)
- 8** Large eye cup (19)
- 9** BATT RELEASE button(15)
- 10** Accessory interface shoe (13)
- 11** Battery pack (14)
- 12** STATUS CHECK button(54)
- 13** PICTURE PROFILE button (33)
- 14** MENU button (64)
- 15** HDMI OUT jack (57)
- 16** B button (46)
- 17** A button (46)
- 18** SHOT TRANSITION/FOCUS MARKING button (46)

To attach the shoulder strap

Attach the shoulder strap (optional) to the hooks for the shoulder strap.

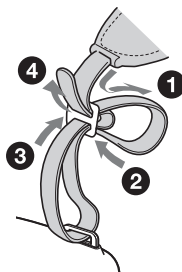

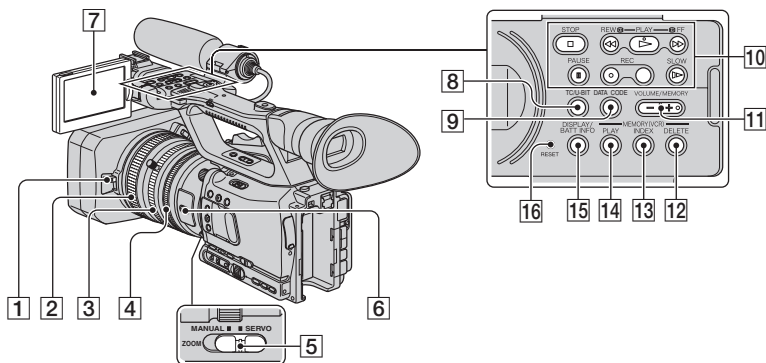

- 1** Lens cover lever (13)
- 2** Focus ring (28)
- 3** Zoom ring (27)
- 4** Iris ring (30)
- 5** ZOOM switch (27)
- 6** DIGITAL EXTENDER/L1 button (43)
- 7** LCD screen (18)
- 8** TC/U-BIT button
Switches between time code and user bit to display on the LCD screen.
- 9** DATA CODE button (53)
- 10** Video control buttons (STOP/REW/PLAY/FF/PAUSE/REC/SLOW) (50)
- 11** VOLUME/MEMORY button (50)
- 12** MEMORY/DELETE button (50)
- 13** MEMORY/INDEX button (50)
- 14** MEMORY/PLAY button (50)
- 15** DISPLAY/BATT INFO button (53)
- 16** RESET button
If you press the RESET button, all settings including the clock setting (except the Picture profile and Camera profile settings) return to the default.

To attach the lens mount cap

Hold the lens mount cap with the ▲ mark facing up. Attach the lens mount cap to the lens mount with the center pin on the back of the cap inserted in the recess at the top center of the lens mount.

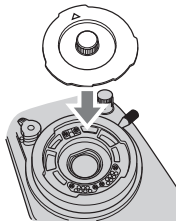

To remove the lens mount cap

Hold the protrusion at the center of the lens mount cap and remove the cap from the lens mount.

To attach the rear lens cap

Attach the rear lens cap to the rear of the lens.

To remove the rear lens cap

Hold the two protrusions on the edge of the rear lens cap as illustrated and remove the cap from the lens.

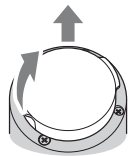

Remote Commander

Remove the insulation sheet before using the Remote Commander.

Insulation sheet

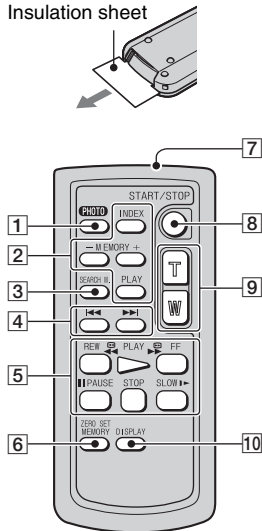

1 PHOTO (26)

The on-screen image when you press this button will be recorded onto the “Memory Stick Duo” as a still image.

2 Memory control buttons (Index, +/-, Memory/playback) (51)

3 SEARCH M. (55)

4 REWIND PLAY

5 Video control buttons (Rewind, Playback, Fast-forward, Pause, Stop, Slow) (50)

6 ZERO SET MEMORY DISPLAY

This button is invalid with your camcorder.

7 Transmitter

8 START/STOP (24)

9 Power zoom (27)

10 DISPLAY (53)

Notes

- Aim the Remote Commander towards the remote sensor to operate your camcorder.
- Point the remote sensor away from strong light sources such as direct sunlight or overhead lighting. Otherwise, the Remote Commander may not function properly.
- When you are operating with the Remote Commander supplied with your camcorder, your VCR may also operate. In that case, select a commander mode other than VTR 2 for your VCR, or cover the sensor of your VCR with black paper.

To change the battery of the Remote Commander

- ① While pressing on the tab, inset your fingernail into the slit to pull out the battery case.
- ② Place a new battery with the + side facing up.
- ③ Insert the battery case back into the Remote Commander until it clicks.

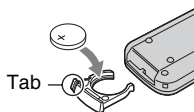

WARNING

Battery may explode if mistreated. Do not recharge, disassemble or dispose of in fire.

- When the lithium battery becomes weak, the operating distance of the Remote Commander may shorten, or the Remote Commander may not function properly. In this case, replace the battery with a Sony CR2025 lithium battery. Use of another battery may present a risk of fire or explosion.

Indicators for the LCD screen and viewfinder

The numbers in () are reference pages.

The indicators will not be recorded on the tape during recording.

Recording movies

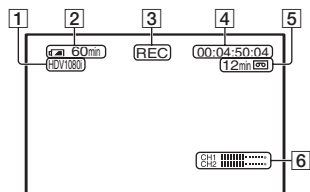

- 1 Recording format (HDV1080i or DVCAM, DV \overline{SP}) (83)
- 2 Remaining battery (approx.)
- 3 Recording status ([STBY] (standby) or [REC] (recording))
- 4 During recording:
Tape counter (hour: minute: second: frame)
During playback:
Time code (hour: minute: second: frame)
- 5 Recording capacity of the tape (approx.)
- 6 Audio level display (81)

Recording still images

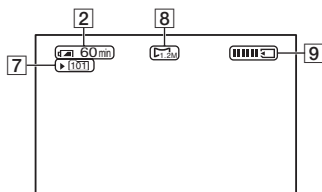



- 7 Recording folder (90)
- 8 Image size (26)
- 9 Recording indicator (26)

Data code during recording

The date/time during recording and the camera setting data will be recorded automatically. They do not appear on the screen during recording, but you can check them on the screen by pressing the DATA CODE button during playback (p. 53).

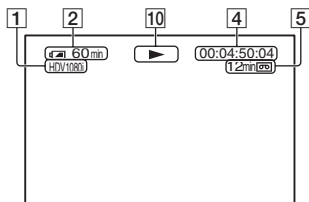

Viewing movies

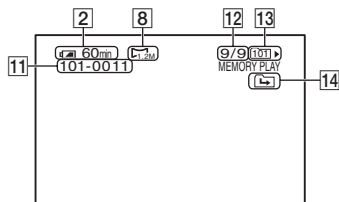

- 10** Tape transport indicator
Recording mode (DVCAM or DV SP) appears when a tape recorded in the DVCAM or DV SP format is played back.  

Viewing still images



- 11** Data file name
- 12** Picture number/Total number of recorded pictures in the current playback folder
- 13** Playback folder (90)
- 14** Previous/Next folder icon
The ,  or  appears when the first or last picture of the current folder is displayed and when there are multiple folders on the same "Memory Stick Duo." You can move to Previous/Next folder with the VOLUME/MEMORY button.

Indicators when you made changes

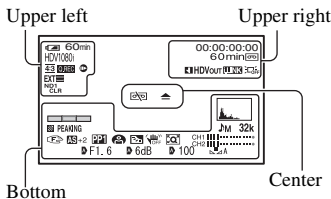

Upper left

Indicator	Meaning
HDV1080i	Recording format (83)
DVCAM DV	
4:3	DV WIDE REC (85)*
Q.REC	QUICK REC (92)**
▶	DV FRAME REC (74)*
ND1 CLR ND2 1/4	ND filter (30)
ND3 1/16 ND4 1/64	
ND	
Interval icon	INTERVAL REC (73)
EXT EXT	EXT REC CTRL (86)
EXT CF	
25pSCAN 25P	REC TYPE SCAN TYPE (84)

Upper right

Indicator	Meaning
IM	INDEX MARK (44)
HDVIn DVIn	HDV input/ DV input (98)
HDVout DVout	HDV output/ DV output (97)
i.LINK	i.LINK connection (57, 94)
Off	LCD backlight off (18)

Center

Indicator	Meaning
Warning icon	Warning (113)

Bottom

Indicator	Meaning
Histogram icon	HISTOGRAM (79)
Leveling bar icon	CAM LEVELING (80)
32k 48k	DV AU.MODE (DV Audio mode) (76)*
M	Manual volume control(41)
Focus icon	Manual focus (28)
PP1 ~ PP6	Picture profile (33)
Spotlight icon	SPOTLIGHT (71)
Backlight icon	BACK LIGHT (71)
SteadyShot off icon	SteadyShot off (72)
PEAKING	PEAKING (79)
D.Extender icon	D.EXTENDER (72)
AS	AE SHIFT (70)
Auto setting icon	Auto setting (81)
ECS	Extended clear scan (31, 71)
White balance icons	White balance (32)
Focus Macro icon	FOCUS MACRO (72)
HYPHER	HYPHER GAIN (69)
(COLOR)	x.v.Color (75)**
Zebra icon	ZEBRA (79)

* The settings can be made only for the pictures in the DVCAM (DV) format.

** The setting can be made only for the pictures in the HDV format.

Tips

- Indicators may look different or appear at different positions.

Index

Numeric

21-pin adaptor.....63

A

A button.....46
Access lamp.....23
Accessory shoe.....130
Accessory shoe adaptor.....131
Accessory shoe kit.....8
Accessory shoe mount.....130
Accessory shoe plate.....130
ADVANCE.....79
AE RESPONSE.....71
AE SHIFT.....70, 106
AE SHIFT button.....43
AE WINDOW.....70
AF ASSIST.....72
AGC LIMIT.....69
ALL ERASE.....89
ALL FILES.....89
ALL OUTPUT.....83
ASPECT.....80
ASSIGN BTN.....91
ASSIGN buttons.....43
AT IRIS LMT.....71
ATW SENS.....70
AUDIO CH SEL.....78
AUDIO LEVEL (CH1)
dial.....41
AUDIO LEVEL (CH1)
switch.....41
AUDIO LEVEL (CH2)
dial.....41
AUDIO LEVEL (CH2)
switch.....41
AUDIO LIMIT.....76
AUDIO SET menu.....76
AUTO ADJUST.....11
AUTO/MANUAL switch.....30
AU. MAN GAIN.....77
AU.LVL DISP
(Audio level display).....81

A/V connecting cable..... 58, 94
A/V connecting cable with
S VIDEO..... 62, 94
A/V OUT jack..... 58

B

B button..... 46
BACK LIGHT..... 71, 106
BAR..... 81
BATT RELEASE (battery
release) button..... 15
Battery..... 14
Battery Info..... 54
BEEP..... 92
Black balance..... 33
BLACK FADER..... 72
BLACK GAMMA..... 35
BLACK LEVEL..... 35
BLK BALANCE..... 33
Button-type lithium battery
..... 136

C

Cable holder..... 10, 12
CAM DATA DSP (Camera
data display)..... 81, 106
CAM LEVELING..... 80
CAMERA PROF.
(Camera profile)..... 90, 106
CAMERA SET menu..... 69
Carl Zeiss lens..... 8
Cassette
Insert/Eject..... 22
Tape..... 116
Cassette compartment..... 22
CH1..... 12
CH1 AUDIO LEVEL dial ... 41
CH2..... 12
CH2 AUDIO LEVEL dial ... 41
Charge lamp..... 14
Charging time..... 15
CLOCK SET..... 20, 91

CNTRST ENHCR..... 71, 106
COLOR BAR..... 75
COLOR CORRCT (Color
Correct)..... 37
COLOR DEPTH..... 37
COLOR LEVEL..... 36
COLOR MODE..... 36
COLOR PHASE..... 36
COMPONENT OUT jack..... 58
Component video cable..... 58
Connect
TV..... 57
VCR..... 94
Connecting cord..... 16
COPY..... 40
CURRENT FLDR..... 89

D

DATA CODE button..... 53
Date and time..... 21, 137
DATE REC..... 92, 106
Date search..... 55
DEGREE..... 81
Deleting camera profile settings
..... 91
Deleting still images..... 51
DETAIL..... 39
DIGITAL EXTENDER
button..... 43
DISP OUTPUT..... 83
DISPLAY SET menu..... 79
DISPLAY/BATT INFO
button..... 18, 53, 54
DOWN CONVERT..... 85
DRUM RUN..... 93
Dubbing..... 94
DV..... 83
DV AUDIO MIX..... 78
DV AU. MODE
(DV Audio mode)..... 76
DV format..... 84
DV FRAME REC..... 74, 107

- DV PROGRE 84
 DV REC MODE
 (Recording mode) 84
 DV SP 84
 DV WIDE CONV 85
 DV WIDE REC 84, 85
 DVCAM 84
 D.EXTENDER
 (Digital Extender) 72, 106
- E**
- ECS FREQ. 71, 107
 ECS (Extended clear scan) ... 31
 End search 45
 END TRIGGER 73
 Expanded focus 29
 EXPANDED FOCUS button
 29, 43
 EXP.FOCUS TYPE 80
 EXT ONLY 86
 EXT REC CTRL 86, 107
 Extended clear scan (ECS) ... 31
- F**
- FADER 72, 106
 FILE NO. (File number) 89
 FLANGE BACK 76, 106
 Flange focal length 10
 FLCKR REDUCE 71
 Focus 28
 FOCUS DISP 81
 FOCUS MACRO 72, 106
 FOCUS MARKING 75
 Focus marking 49
 Focus ring 28
 FOCUS TRANS 46
 Folder
 NEW FOLDER 89
 PB FOLDER (Playback
 folder) 90
 REC FOLDER (Recording
 folder) 90
- FORMAT 89
 FREE RUN 87
 FS32K 76
 FS48K 76
- G**
- Gain 31
 GAIN button 31
 GAIN SETUP 69
 Gain switch 31
 GAMMA 35
 Grip belt 17
 GUIDEFRAME 80
- H**
- HANDLE ZOOM 72
 Handle zoom 27
 Handle zoom lever 27
 Handle zoom switch 27
 HDMI cable 58
 HDMI OUT jack 58
 HDV 84
 HDV format 115
 HDV PROGRE. 84
 HDV1080i 83
 HDV/DV format 83
 HDV/DV jack 59
 Headphones jack 133
 High definition TV 57
 HISTOGRAM 79, 106
 Hook for shoulder strap 134
 HOURS METER 93
 HYPER GAIN 69
- I**
- INDEX MARK 44
 Index screen 51
 Index search 55
 Index signal 44
 Indicators 139
 INDOOR 32
- Indoor 32
 INPUT1 jack 12, 41
 INPUT1 MIC NR 77
 INPUT1 switch 41
 INPUT1 TRIM 77
 INPUT1 WIND 77
 INPUT2 12, 41
 INPUT2 jack 41
 INPUT2 MIC NR 77
 INPUT2 switch 41
 INPUT2 TRIM 77
 INPUT2 WIND 77
 Insulation sheet 136
 INTELLIGENT 70
 INTERLACE 84
 INTERVAL 73
 INTERVAL REC 73, 106
 IN/OUT REC menu 83
 Iris ring 30
 IRIS switch 30
 IRIS TRANS 46
 i.LINK 121
 i.LINK cable 59, 98, 100
 i.LINK Cradle 13
 i.LINK SET 86
- J**
- JPEG 119
- K**
- KNEE 36
- L**
- L1 button 43
 L2 button 43
 LANC jack 130
 LANGUAGE 91
 Large eyecup 19
 Last scene review 45
 LAST SCN RVW 45
 LCD 18

Index (Continued)

- LCD backlight 18
LCD BL LEVEL 82, 106
LCD BRIGHT 82
LCD COLOR 82
Lens 10
Lens cover lever 13
Lens hood with lens cover 12
LENS jack 10
Lens mount cap 135
LETTER SIZE 82
LINKED 77
- ### M
- MANU ADJUST 11
MANU WB TEMP 70
MARKER 80, 106
Memory A 32
Memory B 32
Memory Recording Unit 13
MEMORY SET menu 89
Memory Stick 2
“Memory Stick” 119
“Memory Stick Duo” 22, 119
 Insert/Eject 22
 Number of recordable pictures 26
 Write-protect tab 119
Memory Stick Duo slot cover 22
MEMORY/DELETE button 51
MEMORY/INDEX button 50
MEMORY/PLAY button 50
- Menu
 AUDIO SET menu 76
 CAMERA SET menu 69
 DISPLAY SET menu 79
 IN/OUT REC menu 83
 MEMORY SET menu 89
 Menu items 66
 OTHERS menu 90
 TC/UB SET menu 87
 Using the menu 64
MENU button 20
Menu items 66
Microphone 10, 12
Microphone fixing clasper 12
Microphone holder 10, 12
MIC+48V 41
MIX 78
Mode A 28
Mode B 28
Moisture condensation 123
MPEG2 102
- ### N
- ND filter 30
NEW FOLDER 89
NORMAL 79
NTSC 109, 115
NUMBER 81
- ### O
- ONE PUSH AF 29
One push auto focus 29
One push button 33
OPEN/EJECT lever 22
OPERATION 93
OTHERS menu 90
Outdoor 32
Outside power source 16
- ### P
- PAL 115
PB FOLDER (Playback folder) 90
PB ZOOM (Playback zoom) 92
PEAKING 79, 106
Picture profile 33
PICTURE PROFILE button 33
Picture Search 51
PLAY button 50
Playing time 15
Power cord 16
Pre-installed rechargeable battery 125
PRESET 87
PROFILE NAME 40
PROGRESSIVE 84
PUSH AUTO button 30
PUSH AUTO FOCUS button 29
PUSH (lens hood release) button 12
- ### Q
- QUICK REC 92
- ### R
- Rear lens cap 135
REC CH SELECT switch 12
REC CTL MODE 86
REC FOLDER (Recording folder) 90
REC FORMAT 83
REC LAMP[F] 92
REC LAMP[R] 92
REC LINK 46
REC PAUSE 86
Rec review 45
REC REVIEW button 45
REC RUN 87
REC START/STOP button 24
REC TIME 73
REC TIMING 73
REC TYPE 84
Recording 24
Recording lamp 24
Recording time 15
REGENERATE 87

RELAY86
 REMAINING82
 Remaining battery54
 Remote Commander136
 REMOTE CTRL (Remote control)93
 RESET40, 87
 RESET button135
 RET button43

S

S VIDEO jack57, 94
 SAFETY ZONE80
 SCAN TYPE84
 SEARCH M55
 Self-diagnosis display113
 SEL/PUSH EXEC dial20
 SEPARATE77
 SHOT TRANSITION75
 Shot transition46
 SHOT TRANSITION/FOCUS MARKING button46
 Shoulder strap134
 SHUTTER DISP81
 Shutter speed31
 SHUTTER SPEED button31
 SKINTONE DTL (Skintone detail)40
 Skip Scan51
 Slot23
 SMOOTH GAIN69
 SMOOTH WB70
 SMTH SLW REC (Smooth slow recording)73, 106
 Specifications126
 SPOTLIGHT71, 106
 START TIMER46
 START TRIGGR73
 Status check54
 STATUS CHECK button54

STBY COMMAND86
 STEADYSHOT72, 106
 STOP86
 Supplied items8
 SYNCHRONOUS86
 S.TRANS/F.MARK75

T

Tape counter137
 TAPE RUN93
 Tape See Cassette
 TC COUNTUP87, 107
 TC LINK87, 107
 TC MAKE87
 TC PRESET87
 TC RUN87
 TC/UB SET menu87
 TC/U-BIT button135
 Telephoto27
 Test chart10
 THREADING93
 Time code137
 TONE75
 Trademark129
 TRANS TIME46, 74, 75
 Transmitter136
 Troubleshooting103
 TV57
 TV color systems115

U

UB PRESET87
 UB TIME REC88
 UB-DATE/TC-TIME... 88, 107
 Using the menu items64
 Using your camcorder abroad115

V

VCR HDV/DV83
 VF B.LIGHT82, 106

VF COLOR82
 VF POWER MODE82
 Video control buttons134
 Video head124
 VIDEO OUT85
 Viewfinder18
 Viewfinder lens adjustment lever18
 Viewfinder release lever130
 Volume41, 51
 VOLUME/MEMORY button50
 V-OUT/PANEL83

W

Warning indicators113
 Warning messages114
 WB OUTDR LVL69
 WB PRESET69
 WB SHIFT38
 WB TEMP SET70
 White balance32
 White balance memory switch33
 WHITE FADER72
 WHT BAL button32
 Wide angle27
 Wind screen12
 WORLD TIME91, 107
 Write-protect tab117, 119

X

XLR SET76, 78
 x.v.Color75, 107

Z

ZEBRA79, 106
 ZEBRA button43
 Zoom27
 ZOOM DISPLAY81
 Zoom lever27

Index (Continued)

Zoom ring	27
ZOOM switch.....	27
ZOOM TRANS	46

