

OSMO⁺

User Manual

V1.0 2017.04

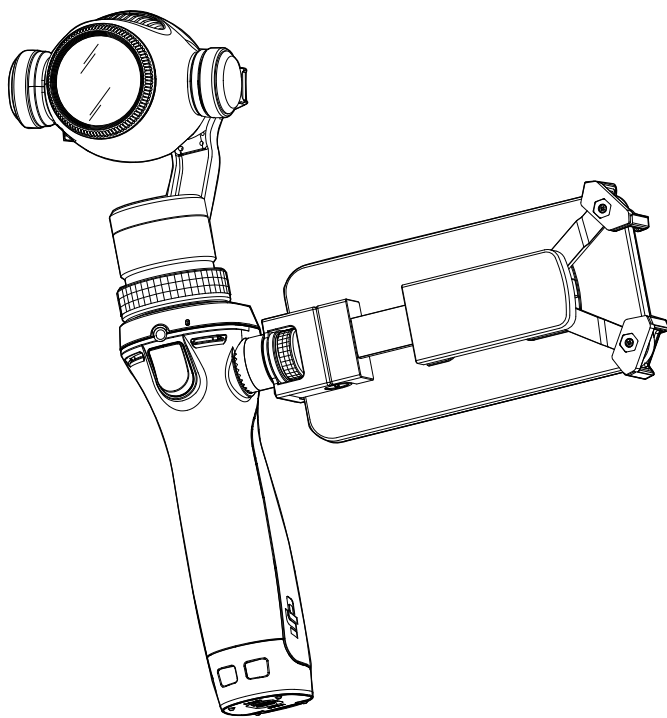

Searching for Keywords

Search for keywords such as “battery” and “install” to find a topic. If you are using Adobe Acrobat Reader to read this document, press Ctrl+F on Windows or Command+F on Mac to begin a search.

Navigating to a Topic

View a complete list of topics in the table of contents. Click on a topic to navigate to that section.

Printing this Document

This document supports high resolution printing.

Using this Manual

Legend

 Important

 Tips

Install the DJI GO App

Search for ‘DJI GO’ on the App Store or Google Play and install the app on your mobile device.



 DJI GO supports iOS 8.0 (or later) or Android 4.3 (or later).

Contents

Using this Manual	2
Legend	2
Install the DJI GO App	2
Introduction	4
Getting Started	5
Intelligent Battery	5
Mounting your Mobile Device	7
Removing the Mobile Device Holder	8
Optional Accessories	8
Unlocking the Gimbal	9
Locking the Gimbal	10
Using the Osmo+	10
Controls and Operations	10
Operation Modes	13
DJI GO App	15
Download	15
Connecting to the DJI GO App	15
Key Pages	16
Upgrading the Firmware	21
Using the DJI GO App	21
Using a Micro SD Card	21
Maintenance	22
Specifications	22
Troubleshooting	25

Introduction

The OSMO™+ is a professional handheld gimbal camera that combines mobility and stability in one device. Its camera features an optical zoom lens providing 3.5x optical zoom and 2x lossless digital zoom*. It shoots sharp 12MP still photos and stable video at up to 4K. A light and ergonomic design places buttons at your fingertips, forming a powerful and personal one-handed filmmaking device. The DJI GO app complements the Osmo+ with shooting modes such as motion timelapse and 9-shot panorama.

Equipped with 3-axis stabilization and SmoothTrack technology, the Osmo+ compensates for natural arm movements and smooths out transitions. Finer operations can be done with the joystick, while instant positioning of the camera can be made directly with your other hand. The camera tilts across a 170-degree range and has a pan rotation of 640 degrees. The DJI Rosette Mount on the side of the handle allows your mobile device to be mounted as a live HD view finder, and supports external devices including vehicle mounts and tripods for specialized filmmaking applications.

At a Glance:

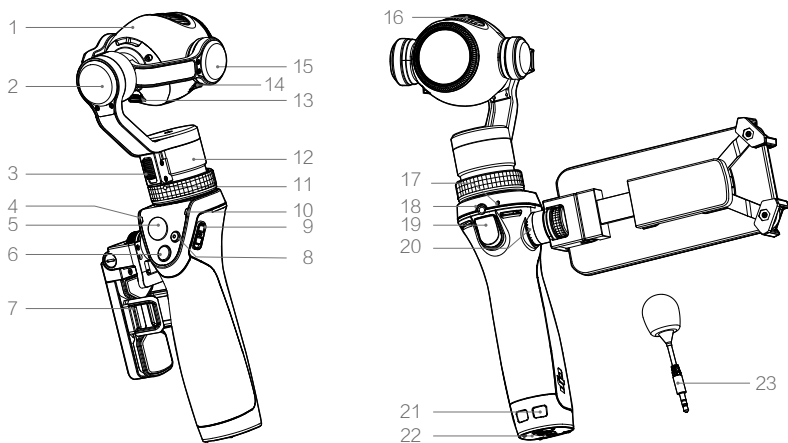

- | | | |
|------------------------|--------------------------|------------------------------|
| 1 Camera | 9 Power Switch | 17 Built-in Microphone |
| 2 Roll Motor | 10 System Status LED | 18 External Microphone Input |
| 3 Pan Axis Lock | 11 Gimbal Securing Ring | 19 Trigger |
| 4 Camera Status LED | 12 Pan Motor | 20 DJI Rosette Mount |
| 5 Joystick | 13 Camera Micro USB Port | 21 Lanyard Hole |
| 6 Shutter Button | 14 Micro SD Card Slot | 22 Battery Cover |
| 7 Mobile Device Holder | 15 Tilt Motor | 23 Flexi Microphone |
| 8 Record Button | 16 Air Vents | |

*Digital lossless zoom only available when shooting at 1080p.

Getting Started

Intelligent Battery

The 1225 mAh Intelligent Battery can power the Osmo+ for about 114 minutes.

Charging the Battery

Connect the battery charger to a power outlet using the provided cable.

Place the battery into the battery charger. It will take approximately 110 minutes for the battery to be fully charged, refer to the "Status LED Indicator Descriptions" section below for more information about the Status LED Indicator's blinking patterns.

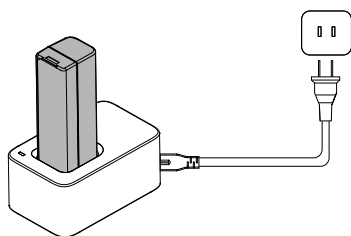

Status LED Indicator Descriptions

Status LED Indicator	Descriptions
☹ — Solid Yellow	No battery detected
☹	Blinks once < 25%
Blinking Green (within a certain time)	Blinks twice 25% to 49%
	Blinks three times 50% to 74%
	Blinks four times 75% to 99%
☺ — Solid Green	Fully charged
☹ — Solid Red	Charger error, check the connection to the Battery Charger

Intelligent Battery Functions

Battery Balancing	Balances the voltage of each cell during charging.
Overcurrent Protection	Stops charging if the charging current is too large.
Overcharge Protection	Stops charging if its voltage is too high.
Over-discharge Protection	Stops discharging if its voltage is too low.
Short Circuit Protection	Cuts the power supply if a short circuit is detected.
Temperature Control	Stops charging if the core temperature falls below 41°F (5°C) or exceeds 104°F (40°C).
Battery Level Display	The battery level is displayed in the DJI GO app.

Battery Specifications

Model	HB02-542465
Type	LiPo
Capacity	1225 mAh
Energy	14.1 Wh
Voltage	11.1 V
Charging Temperature	41° to 104° F (5° to 40° C)
Operating Temperature	32° to 104° F (0° to 40° C)

- ⚠ • Be sure to fully charge the Intelligent Battery for the first time to activate it.
- Read the user manual, Intelligent Battery Safety Guidelines before use. The user takes full responsibility for all operations and usage.

Battery Charger Specifications

Model	OS1C11
Input	100-240 V, 50/60 Hz
Output	12.6 V/13.2 V; 0.8 A

- ⚠ • Only charge the battery with the provided battery charger. DJI takes no responsibility for accidents caused by the use of non-DJI battery chargers.
- Remove the battery from the charger unless it is charging to prevent battery discharging.

Inserting the Battery

Slide the locking switch at the base of the Osmo+ to open the battery cover. Insert the battery and lock the battery cover.

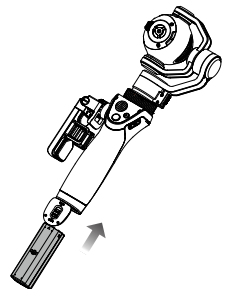

Removing the Battery

Slide the locking switch at the base of the Osmo+ to open the battery cover. Push the red safety hook away from the battery to let it pop up, and then remove the battery.

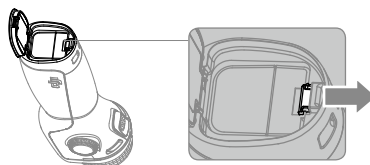

Mounting your Mobile Device

1. Unfold the two arms on the mobile device holder.
2. Adjust the pads to the desired position.

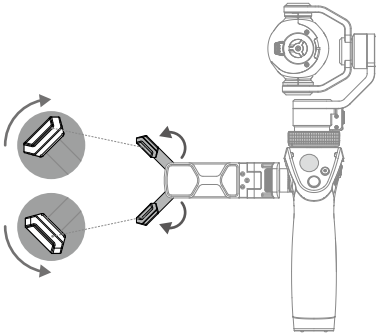

3. Place one end of your mobile device into the arms.
4. Extend the arms so that your entire mobile device is seated in the mobile device holder.

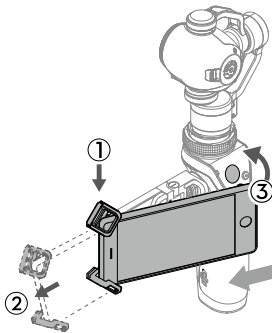

5. Rotate your mobile device to the desired position.

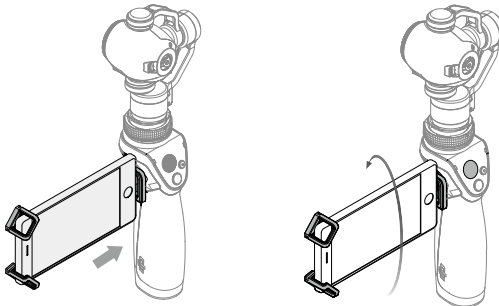

Removing the Mobile Device Holder

1. The mobile device holder can be removed by rotating the knob counterclockwise.
2. It is recommended to install the cap for the DJI Rosette Mount when it is not in use.

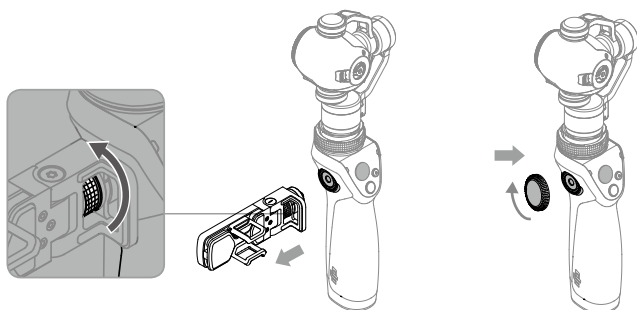

Optional Accessories

DJI provides various optional accessories for the Osmo+.

Z-Axis

The Osmo Z-Axis can significantly reduce vertical shaking from natural arm movements when walking and jogging.

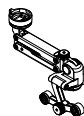

Universal Mount

Used to mount external devices such as a microphone or flashlight.

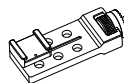

Extension Rod

Good for taking group selfies, overhead shots or reaching into small spaces.

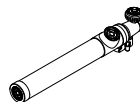

Tripod

For stationary shots that require steady footage. It must be used with the Extension Rod.

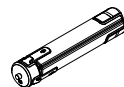

Bike Mount

Used to mount the Osmo+ on a bicycle.



Vehicle Mount

Triple suction cup mount makes it ideal for mounting on top of or on the rear window of moving vehicles.



Straight Extension Arm

Used to attach up to three other mounts at the same time.

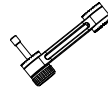

☀️ • Visit the official DJI Store (<http://store.dji.com>) to learn more.

Unlocking the Gimbal

To protect the gimbal, the motor axes are locked in place. To unlock the gimbal:

1. Gently rotate the roll motor until it can rotate freely.

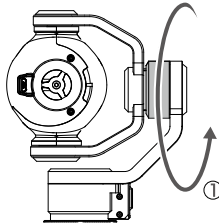

⚠️ • Rotate the motor just enough to allow free motion.

2. Slide the Pan Axis Lock upwards to unlock the pan axis.

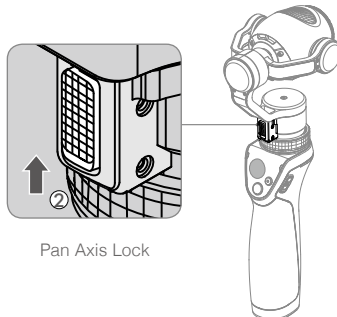

Pan Axis Lock

- ⚠ • You can choose to unlock the gimbal before or after the Osmo+ is turned on. It is recommended to unlock the gimbal before powering on the Osmo+.
 - The Osmo+ will beep slowly if the gimbal is locked after it is turned on. This means the camera is working normally but the gimbal is shut off.
 - If you need to unlock the gimbal after it is turned on, you must rotate the pan motor to reactivate the gimbal.
-

Locking the Gimbal

Pull the pan axis lock down and rotate the pan axis to the locked position (until it cannot rotate any further), and then adjust the roll motor in order to lock it in place.

- ⚠ • Do not lock the gimbal during recording, otherwise the recording will stop.
-

Using the Osmo+

Controls and Operations

The gimbal anticipates handle movement to smooth out pan and tilt transitions, and uses SmoothTrack technology to reduce camera shakes from natural arm movements. The camera can be positioned directly by hand.



Additionally, there are buttons on the front and back of the handle that allow for finer control over the gimbal and camera. All of the buttons and controls are described below.

[1] Power Switch

To turn on the Osmo+, pull the power switch down and then release it.

Pulling the power switch again will cause the Osmo+ to go in or out of sleep mode.

To turn off the Osmo+, pull the power switch down and hold for 1.5 seconds.

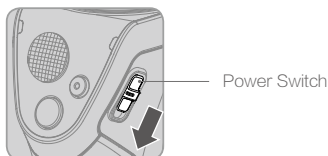

- ⚠ • Hold the Osmo+ steady and upright while it is starting up.
-

[2] Joystick

Vertical movement tilts the camera. Horizontal movement pans the camera. Joystick Control Direction can be changed in the DJI GO app.

[3] Shutter Button

Press this button to take photos based on your settings in the DJI GO app. Hold down shutter button to capture continuous photo.

[4] Record Button

Press this button once to start recording video, and again to stop recording.

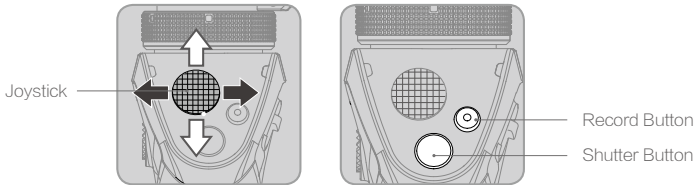

[5] Camera Status Indicator

Indicates the camera's system status. Refer to the table below for details.

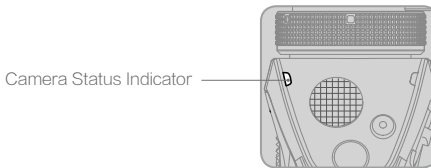

Blinking Pattern	Description
○ LED Off	Camera is functioning normally.
⊙ ·····	Blinks Green Shooting photo.
⊙ ······	Blinks Green slowly Self-timer.
⊙ ··· ···	Blinks Green for each shot Burst shooting.
⊙ —	Solid Green Firmware upgrade successful.
⊙ ·····	Blinks Red slowly Recording video.
⊙ / ⊙ ·····	Blinks Red and Green alternately Upgrading firmware.
⊙ —	Solid Red Camera is not mounted on the Osmo+ properly / Firmware upgrade failed or system error.
⊙ ×2 ·····	Blinks Red twice Camera error.
⊙ ·····	Blinks Yellow Micro SD card busy.
⊙ —	Solid Yellow Micro SD card error.

[6] System Status Indicator

Indicates the status of the Osmo+. Refer to the table below for details.

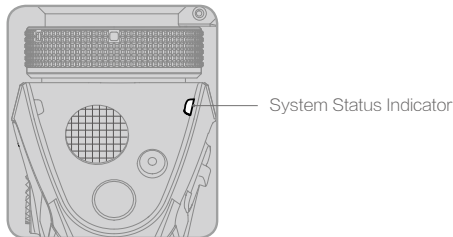

System Status Indicator	Description
..... Blinks Green quickly	The Osmo+ is initializing / Exiting sleep mode.
..... Blinks Red slowly	Low battery level warning.
..... Blinks Red quickly	Critical low battery level warning.
— Solid Yellow	The trigger is tapped and the gimbal is in lock mode.
— Solid Red	Non-DJI battery detected.
— Breathing Green (high battery level)	The Osmo+ is in sleep mode.
— Breathing Red (low battery level)	

[7] Trigger

- Hold down the trigger and push the joystick up and down to zoom.
- Hold down the Trigger to enable Lock Mode. The camera will stay in its current position regardless of handle movement. The Osmo+ will return to SmoothTrack Mode once the Trigger is released.
- Quickly tap the Trigger twice to center the camera.
- When the Osmo+ is in Upright Mode and Underslung Mode, quickly tapping the Trigger three times will enter Selfie Mode.

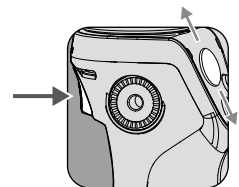

External
Microphone Input

Built-in
Microphone

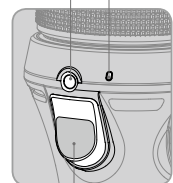

[8] External Microphone Input

Connect the provided Flexi Microphone to record audio.

[9] Built-in Microphone

Records audio for general use. You can turn off the microphone in the DJI GO app.

-
- ⚠ • The external microphone will override audio reception of the built-in microphone.
-

[10] Key Combination

Restore Default Wi-Fi Settings: Hold down the Trigger and Shutter Button at the same time. Then, pull the power switch down until the System Status Indicator blinks green. Release the power button before releasing the Trigger. The default SSID, password and frequency for the Wi-Fi connection will be restored.

Turn on/off the Osmo+'s Wi-Fi: Press and hold the trigger, then pull down the power switch, then release both power switch and trigger. Wi-Fi is off when the system status LED blinks twice. Repeat to turn on Wi-Fi.

Operation Modes

Upright Mode

Upright Mode can be used without any user input. In this mode, quickly tap the trigger twice to center the camera.

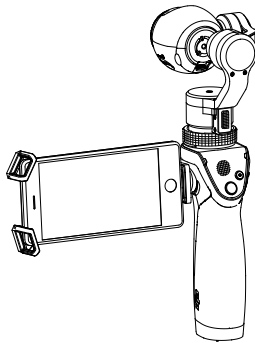

Underslung Mode

Holding the Osmo+ upside down will cause it to enter Underslung Mode, in which the camera can easily capture images from a lower position. Quickly tapping the trigger twice will center the camera.

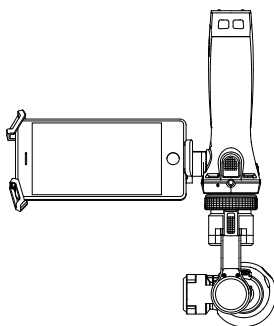

Flashlight Mode

Rotate the Osmo+ forward 90 degrees to go from Upright Mode to Flashlight Mode. In Flashlight Mode, pushing the joystick up and down will tilt the camera, pushing the joystick left and right will have no effect.

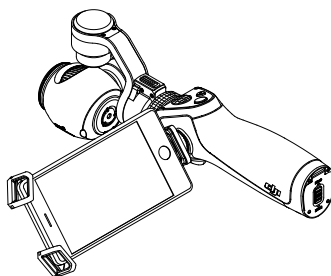

Portrait Mode

Rotate the Osmo+ 90 degrees to the left or right to go from Upright Mode to Portrait Mode.

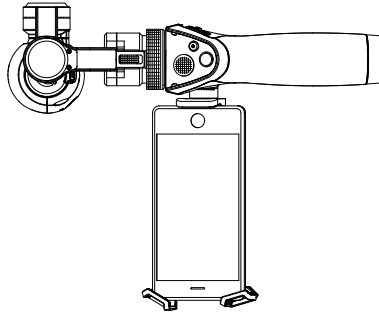

DJI GO App

Watch a live HD video feed on your mobile screen through the DJI GO app. The Osmo+ is complemented by the DJI GO app, which provides shooting modes such as motion timelapse and 9-shot panorama.

The app also allows you to configure camera and gimbal settings in just a few taps.

Download

Search 'DJI GO' on the App Store or Google Play and download the app to your mobile device.

Connecting to the DJI GO App

1. Turn on the Osmo+. Hold the handle still and avoid touching the gimbal while the Osmo+ starts up.

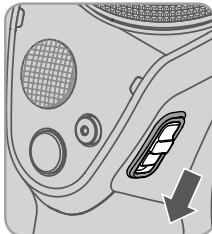

- On your mobile device, connect to the 'OSMO_XXXXXX' Wi-Fi network and enter the default password 12341234. Then launch the DJI GO app.

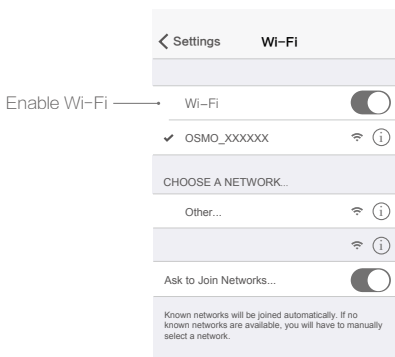

- If you are using the Osmo+ for the first time, follow the on-screen instructions to activate it. You will need to log in to your DJI account through an Internet connection. Re-connect to the Osmo+ Wi-Fi network after the activation is complete.
- Enter Camera View. You will see what the camera captures in real time if it is connected successfully.

 • There will be a tutorial on how to use your Osmo+ after entering the camera view.

Key Pages

1. Equipment > Camera



[1] 

Information Bar

Displays the camera parameters, current battery level, and Wi-Fi signal strength.

[2]  : Auto Focus / Metering Mode

Tap to switch between Auto Focus and Metering Mode.

[3]  : Photo/Video Toggle

Slide to switch between photo and video mode.

[4] Photo/Video Settings

: Photo Modes

- Single Shot

Normal, 5s or 10s delayed shot, HDR.

- Multiple Shots

Burst shooting 3/5/7 frames, Auto Exposure Bracketing (AEB) 3/5 bracketed frames at 0.7EV Bias.

- Panorama

Forward: The camera will rotate 180 degrees and render a panorama.

Auto: The camera will rotate 360 degrees and render a panorama.

Selfie: The camera will point at you, pan 180 degrees and render a panorama.

Manual: The camera will pan a specified degree each time you tap the shutter button. Up to 8 photos can be taken in manual mode to create a panorama. Always keep objects in the right side of the shear.

9-Shot Panorama (Matrix): The camera will pan and tilt to capture a 9-shot grid, creating a large multi-image photo.

- Interval Timer

5s, 10s or 30s intervals.

- Timelapse

There are Regular and Motion Timelapse Mode. In Motion Timelapse Mode, use up to 5 camera positions to create a moving timelapse.

1) Choosing to store timelapse in 'JPEG+Video' format limits the minimum interval to 2 seconds. Disabling this option reduces the minimum interval to 1 second.

2) If the timelapse interval is 2 seconds or more, the camera will apply digital stabilization to the live HD video on your mobile device.

: Video Modes

- Auto: Normal video based on your camera settings.

- Slow Motion: Recorded at 1080p and 100fps.

- [5]  : **Shutter/Record Button**
Shoots photos in photo mode and records video in video mode.

- [6]  : **Camera Parameters**
Choose the shooting mode, ISO, shutter speed and exposure value.

- [7]  : **Playback**
Tap to view photos and videos on the Micro SD card.

- [8]  : **Zoom Button**
Tap T to zoom in and W to zoom out.

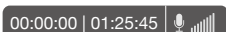
- [9]  : **Recording Status Bar**
Displays the current recording time, remaining recording time and microphone volume.

[10]  : **Settings**

Camera Settings

Here you can select the output formats for photos, video recording, and enable on-screen displays such as histogram. Some of these options are explained below.

- **Video Caption**
If you enable this option, a .srt file containing on-screen information will be created with the video file.

- **Timelapse Format**
Choosing 'JPEG+Video' will save the timelapse photos as well as the video.

- **Anti-Flicker**
Select the frequency that matches the current cycle in your country to prevent the flickering of lights.

- **File Index Mode**
If you select 'Reset', the camera will write the photo and video files starting from the smallest available index. If you select 'Continuous', the camera will continue the index from the last written file.

Gimbal Settings

- **Profiles**
Select the 'Fast', 'Medium' or 'Slow' profile depending on how responsive you want the gimbal to be. Alternatively, create a custom profile by selecting C1 or C2 and configuring the settings below.

- **SmoothTrack Settings**
The pan and tilt axes can be adjusted separately.
Speed: Determines how fast the gimbal will catch up with the translated pan/tilt handle movement.

Deadband: A larger deadband requires more pan/tilt handle movement to translate into gimbal motion.

Acceleration: Determines how closely the camera will follow the translated pan/tilt handle movement.

- **Joystick Settings**

Smoothing: Controls the deceleration of the gimbal. A small value will cause the gimbal to stop abruptly.

Speed: Controls the movement speed of the tilt and pan axes when controlled by the joystick.

Control Direction: The Osmo+'s tilt and pan axis can be controlled simultaneously by setting joystick control direction to Free.

Invert Joystick Left/Right Operation: Inverts left and right joystick directions, so that pushing right turns the camera left and vice versa.

Invert Joystick Up/Down Operation: Invert up and down joystick directions, so that pushing the joystick up tilts the camera down.

- **Horizontal Calibration**

You may have to calibrate the roll axis if the camera's horizon level is not perfectly level by setting a positive or negative value.

- **Auto Calibration**

Reduces the drift caused by magnetic interference in the surroundings or human error. Hold the Osmo+ still and upright during the calibration.

- **Reset Gimbal**

Tap to reset the gimbal to the default settings.

General Settings

Here you can change the Wi-Fi password, clear the video cache.

Livestream

Livestream to YouTube Live.

[11] : Gimbal Functions

Scene Mode: SmoothTrack speed varies depending on the Scene Mode. In Sport Mode, it moves faster, while in Walk Mode it is slower.

When using the Osmo's Wear Mode with the Osmo+, vertical movements created by wearing the Osmo are minimized.

Tap  to recenter the camera.

Tap  enable Lock Mode.

Tap  to enter Selfie Mode.

Tilt Axis Lock: Locks the tilt axis at the current angle when enabled.

Zoom Adjusted SmoothTrack: After enabling this function, SmoothTrack speed will auto

adjust according to the level of zoom.

Focus when Gimbal stops: Enable this function to allow auto focus after the gimbal has stopped moving.

Set Gimbal Attitude: Set gimbal tilt and pan angle manually.

[12]  : **Camera Quick Settings**

A shortcut for changing the video resolution, photo format and photo color; select a predefined or custom white balance; choose style settings for adjusting sharpness, saturation and contrast. Adjust the microphone volume under Audio Volume Control.

[13]  : **Home**

Tap to navigate to the home screen.

Drag Focus

In Camera View, touch the screen and hold until a blue circle appears. Then, drag the circle to control the camera.

2. Editor

View, edit and share your masterpieces all in one place. The Editor has a range of simple but powerful tools that let you edit your videos and photos before sharing them online, minutes after they are captured.

Once you login or register your DJI account, you will be able to conveniently upload and share your creations. The saved photos and videos can be uploaded to Skypixel (www.skypixel.com) and shared on social networks such as Facebook, Twitter, WeChat, Moments and Sina Weibo.

Video

All of your recorded video footage will appear in 'Original Footage'. You can trim footage and save it to 'Create Movie'. Then, select multiple clips to create a movie quickly with the built-in editing tools and templates.

Photos

Edit your photos by adjusting the parameters, editing the photo size, adding watermarks and applying filters.

3. Skypixel

View and share photos and videos to the Skypixel network.

4. Me

If you already have a DJI account, you will be able to participate in forum discussions.

Upgrading the Firmware

Ensure that the battery has at least 50% power. It will take approximately 20 minutes to complete the upgrade. It is recommended to lock the gimbal and place the handle on a flat surface during the upgrade process.

The camera status indicator will blink green and red alternately during the upgrade process, and become solid green when the firmware upgrade is complete. If the Osmo+ upgrade is successful, you will hear a beeping pattern consisting of 1 long beep followed by 2 short beeps. If the upgrade is unsuccessful, the camera status indicator will become solid red and the Osmo+ will emit a fast beeping sound, in which case you should reattempt the upgrade.

Using the DJI GO App

Connect the Osmo+ to your mobile device and then launch the DJI GO app. You will be reminded if a new firmware upgrade is available. To start upgrading, connect your mobile device to the internet and follow the on-screen instructions.

 • A Micro SD card must be inserted into the Osmo+ for the upgrade to start.

Using a Micro SD Card

1. Download the latest firmware update package from the product page on the official DJI website.
2. Copy the .bin file to the root directory of your Micro SD card (ensure there is enough storage), and insert the card into the Micro SD card slot on the camera while the Osmo+ is powered off.
3. Power on the Osmo+ to begin upgrading.

Read the .txt file on the root directory of the Micro SD card to confirm the upgrade result.

 • Restart the Osmo+ and ensure the Camera Status Indicator is off for normal use.

Maintenance

When transporting the Osmo+, keep it locked, in order to protect the gimbal, as shown below.

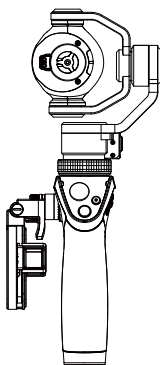

The Osmo+ is not water resistant. Keep it away from sand and dust during use. After use, it is recommended to wipe the Osmo+ down with a soft dry cloth. Never spray any cleaning liquids onto the Osmo+.

Specifications

Handle	
Dimensions	2.4×1.9×6.4 inches (61.8×48.2×161.5 mm)
Weight (including battery)	201 g
Gimbal	
Model	Zenmuse X3 Zoom
Weight	268 g
Output Power (with camera)	8 W
Angular Vibration Range	±0.02°
Mount	Detachable
Controllable Range	Tilt: -35° to +135°
	Pan: ±320°; Roll: ±30°
Mechanical Range	Tilt: -50° to +140°
	Pan: ±330°; Roll: -50° to +90°
Max Controllable Speed	120°/s

Camera	
Model	X3 ZOOM / FC350Z
Sensor	1/2.3" CMOS Effective pixels: 12.40 M (Total pixels: 12.76 M)
Lens	3.5× Optical Zoom 22 - 77mm Equivalent F2.8 (Wide) - F5.2 (Tele) FOV 92° (Wide)- 35° (Tele) Focus: 0.5 m to infinity
ISO Range	100 - 3200 (video); 100 - 1600 (photo)
Electronic Shutter Speed	8 s - 1/8000 s (up to 30 s when camera is in M mode)
Max. Image Size	4000×3000 pixels
Still Photography Modes	Single Shot Photo Burst Mode: 3/5/7 shots Auto Exposure Bracketing (AEB): 3/5 bracketed frames @ 0.7 EV bias Interval Auto Panorama Selfie Panorama 9-Shot Panorama Motion Timelapse Regular Timelapse
Video Resolution	C4K: 4096×2160 24/25p 4K: 3840×2160 24/25/30p 2.7K: 2704×1520 24/25/30p FHD: 1920×1080 24/25/30/48/50/60/100p
Video Recording Modes	Auto Slow Motion
Max. Video Bitrate	60 Mbps
Supported File Systems	FAT32 (≤ 32 GB) exFAT (> 32 GB)
Photo Formats	JPEG, DNG (RAW)
Video Formats	MP4/MOV (MPEG-4 AVC/H.264)
Supported SD Cards	Micro SD Max. Capacity: 64 GB Class 10 or UHS-1
Operating Temperature	32° to 104° F (0° to 40° C)

Audio Output	48 kHz AAC
Wi-Fi Video Link	
Operating Frequency	2.412–2.462 GHz 5.180–5.805 GHz
Max Transmission Distance	82 feet (25 m)
Transmitter Power (EIRP)	2.4 GHz: 8 dBm 5 GHz: 12 dBm
Intelligent Battery	
Model	HB02-542465
Type	LiPo
Capacity	1225 mAh
Energy	14.1 Wh
Voltage	11.55 V
Charging Temperature	41° to 104° F (5° to 40° C)
Operating Temperature	32° to 104° F (0° to 40° C)
Battery Charger	
Model	OS1C11
Input	100–240 V, 50/60 Hz
Output	12.6/13.2 V, 0.8 A
Flexi Microphone	
Sensitivity	-32 ± 3 dB (0 dB = 1 V/Pa)
Frequency Response	100 - 10000 Hz
Signal-to-Noise Ratio	60 dBA
Pin Diameter	3.5 mm
Length	88 mm
Weight	4 g

Troubleshooting

1. Why can't I connect to the Osmo+?

- Check your mobile device's Wi-Fi settings to make sure it is connected to the Osmo+'s Wi-Fi network.
- If the Osmo+'s Wi-Fi network does not appear in your phone's Wi-Fi settings, make sure your mobile device is operating at either the 2.4GHz or 5.8GHz channel and try again.
- If you still cannot connect to the Osmo+ even though your mobile device is connected to the Osmo+'s Wi-Fi network, restart the Osmo+ and try again.

If the problem persists, reset the Osmo+'s Wi-Fi network to its default settings by using the key combination and try again. (Key combination: Hold down the Trigger and Shutter Button at the same time. Then, pull the power switch down until the System Status Indicator blinks green. Release the power button before releasing the Trigger.)

Still can't connect? You can contact our online support at www.dji.com/support to get more help.

2. Why doesn't the gimbal work out of the box?

Ensure you have activated the Osmo+ by linking it to your DJI account. Connect your mobile device to the dedicated Osmo+ Wi-Fi network, launch the DJI GO app, and then follow the on-screen instructions to activate the device.

3. Why does the Osmo+ keep beeping after I turn it on?

The gimbal is locked. Rotate the tilt and roll axes until they can move freely. If the pan axis is locked, slide the Pan Axis Lock up to free the pan axis.

4. What should I do if the battery depletes while I am recording video?

Do not remove the Micro SD card from the camera. Recharge the battery or insert a new one into the handle. The Osmo+ will automatically recover the video file when it starts up.

5. How do I shoot amazing long exposure shots?

Long exposures can be produced by setting a slow shutter speed. In the DJI GO app, choose 'S' mode (Shutter Priority) or 'M' (Manual Mode) and adjust the shutter speed to the desired value. Make sure you hold the camera still for the entire shutter duration.

6. Can I close the DJI GO app or disconnect my mobile device while the Osmo+ is recording video?

Yes. The Osmo+ will continue recording video and still be able to capture photos, but you will lose the ability to preview the shots on your mobile device.

This content is subject to change.

Download the latest version from
<http://www.dji.com/product/osmo-plus>

If you have any questions about this document, please contact DJI by sending a message to **DocSupport@dji.com**.

OSMO is a trademark of DJI.
Copyright © 2017 DJI All Rights Reserved.